

# DN800.630.SL.G.1B

DRAWING No.:	VERSION	REVISION	REVISION STATUS
DN800.630.SL.G.1B	EN	1	ACTUAL

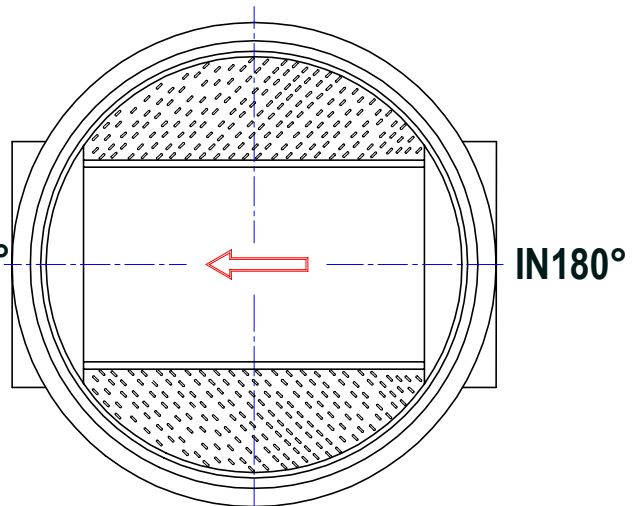

**OUT0° / IN180°**  
DN160, 200, 250, 315, 400 mm

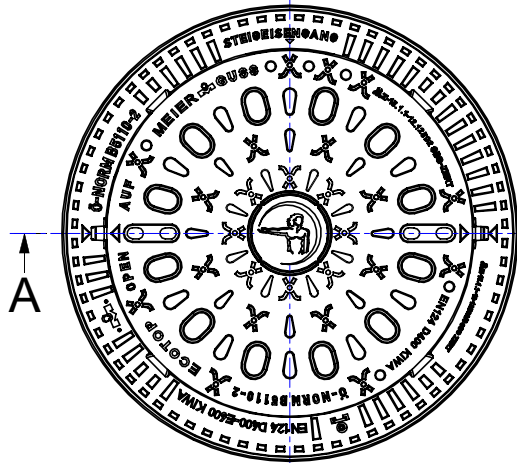
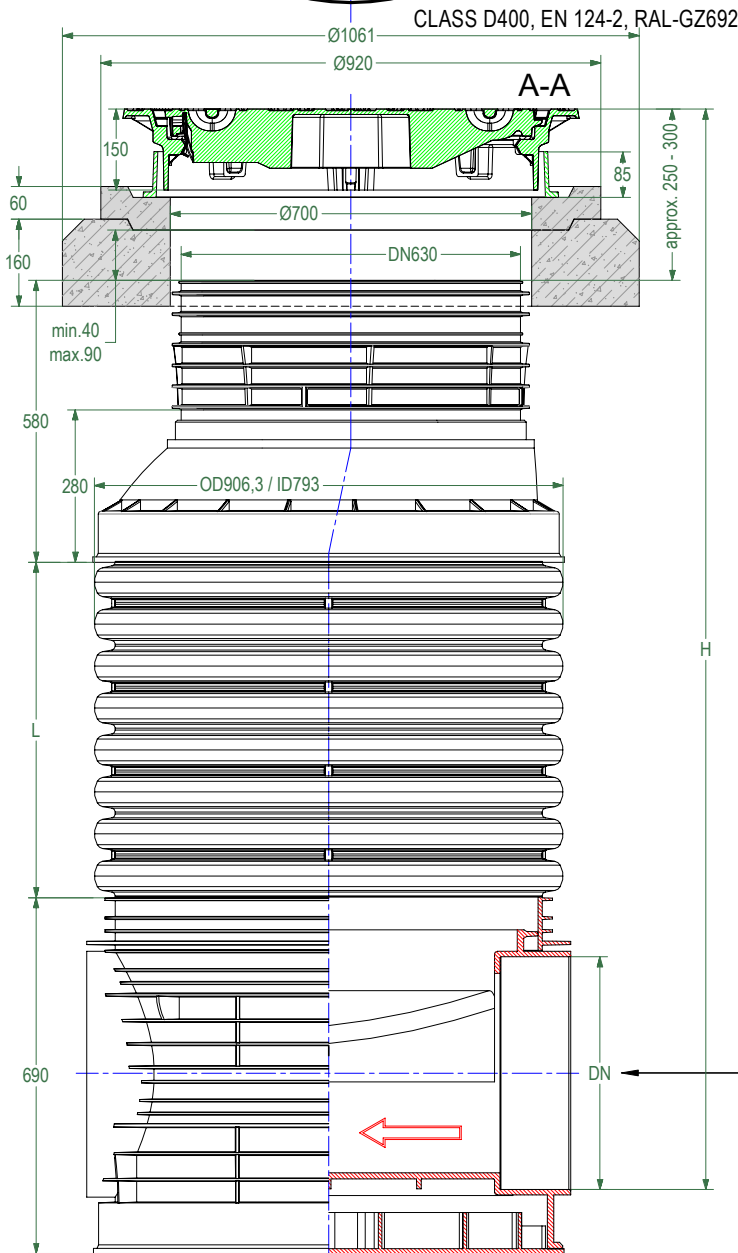

DN/OD, EN 13476-2, EN 1852-1, EN 14758-1

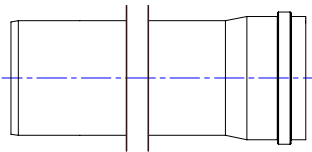

DN/OD, EN 13476-3

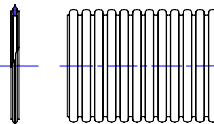

DN/ID, EN 13476-3

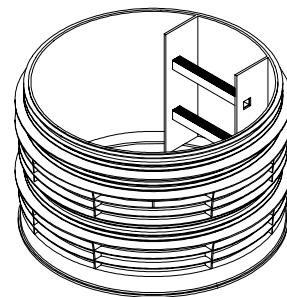
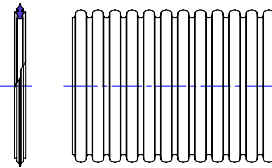

Chamber base connection type is modified according to your project to meet necessary requirements (smooth/corrugated pipe connection).

*This drawing is not suitable for the design and construction of other objects without the consent of SIA "EVOPIPES"*



SIA "EVOPIPES"  
Langervaldes str. 2a, Jelgava, LV-3002, Latvia  
Company reg. No.: 50003728871  
Phone: +371 63094300  
E-mail: [info@evopipes.lv](mailto:info@evopipes.lv)  
Website: [www.evopipes.lv](http://www.evopipes.lv)

FILE NAME:  
DN800.630.SL.G.1B

SHEET: 1 OF 1

SHEET FORMAT: @ A4

SCALE:  
WITHOUT SCALE

STAGE:  
STANDARD DRAWING

# DN800.630.SL.G.2BL

DRAWING No.:	VERSION	REVISION	REVISION STATUS
DN800.630.SL.G.2BL	EN	1	ACTUAL

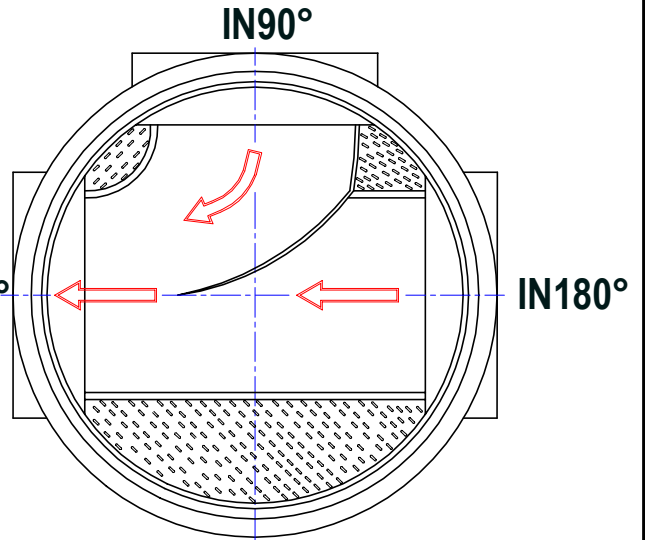
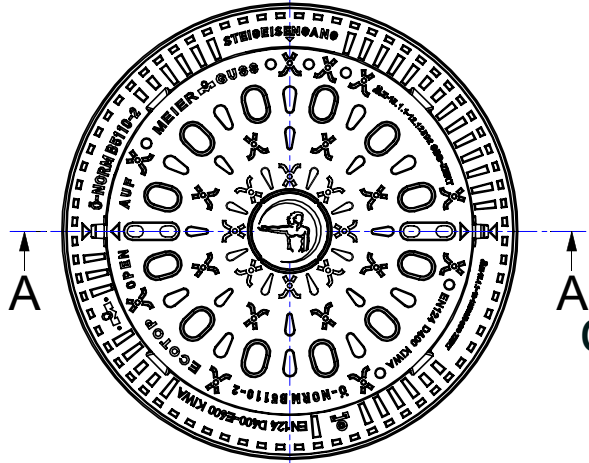

CLASS D400, EN 124-2, RAL-GZ692

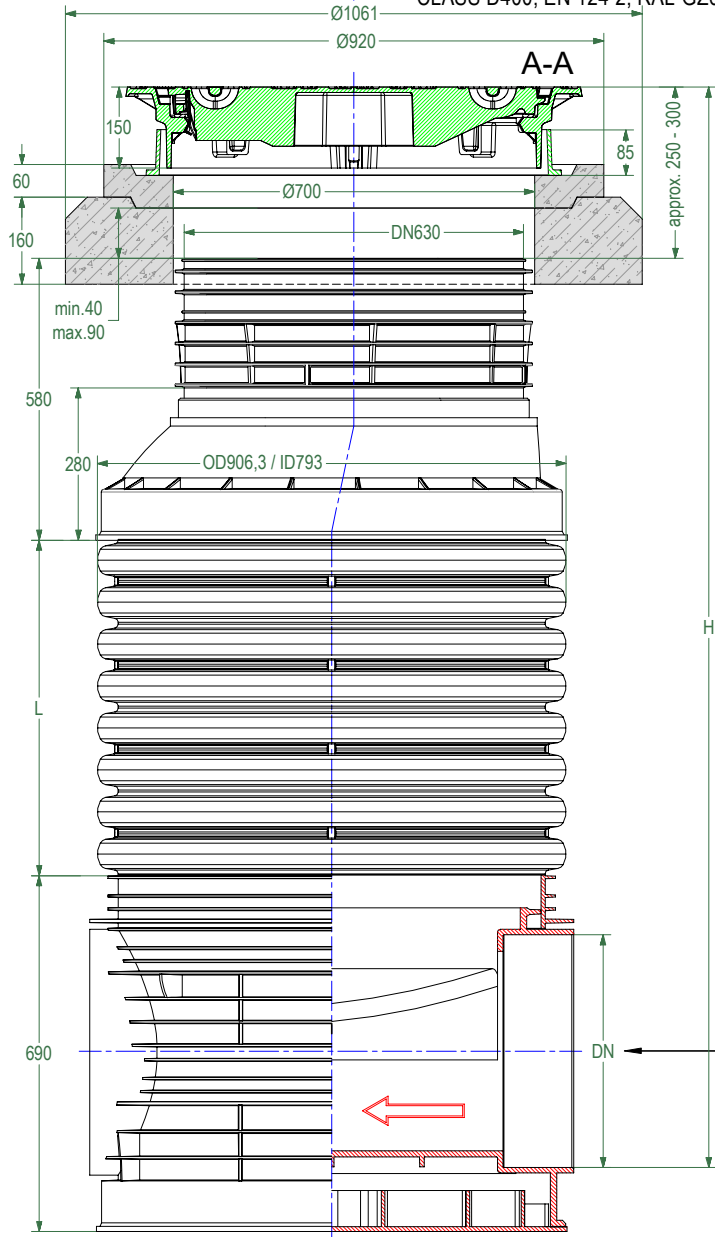

**OUT0° / IN90° / IN180°**  
DN110, 160, 200, 250, 315, 400 mm

DN/OD, EN 13476-2, EN 1852-1, EN 14758-1

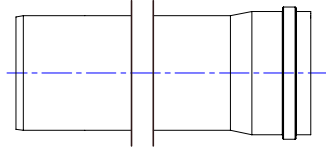

DN/OD, EN 13476-3

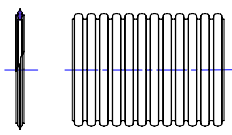

DN/ID, EN 13476-3

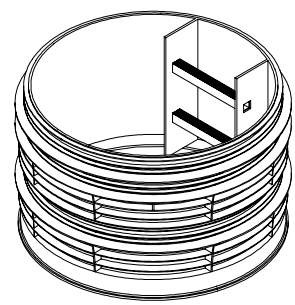
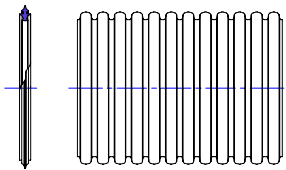

Chamber base connection type is modified according to your project to meet necessary requirements (smooth/corrugated pipe connection).

*This drawing is not suitable for the design and construction of other objects without the consent of SIA "EVOPIPES"*



SIA "EVOPIPES"  
Langervaldes str. 2a, Jelgava, LV-3002, Latvia  
Company reg. No.: 50003728871  
Phone: +371 63094300  
E-mail: [info@evopipes.lv](mailto:info@evopipes.lv)  
Website: [www.evopipes.lv](http://www.evopipes.lv)

FILE NAME:  
DN800.630.SL.G.2BL

SHEET: 1 OF 1

SHEET FORMAT: @ A4

SCALE:  
WITHOUT SCALE

STAGE:  
STANDARD DRAWING

# DN800.630.SL.G.3BL

DRAWING No.:	VERSION	REVISION	REVISION STATUS
DN800.630.SL.G.3BL	EN	1	ACTUAL

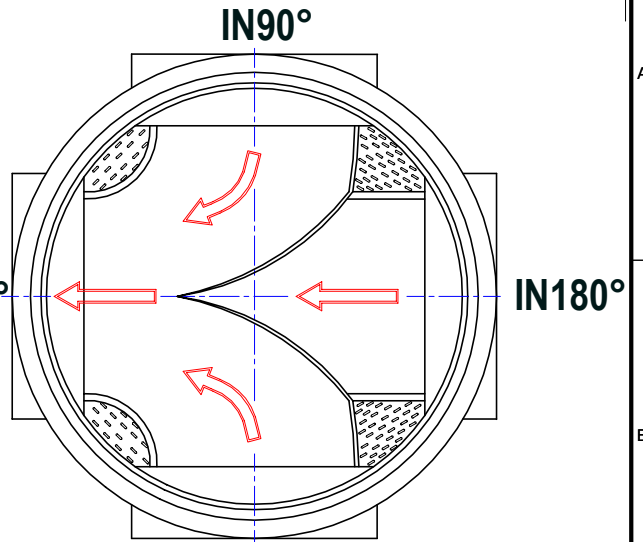
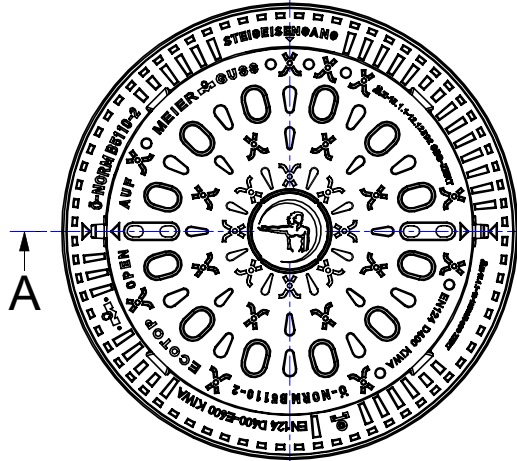

CLASS D400, EN 124-2, RAL-GZ692

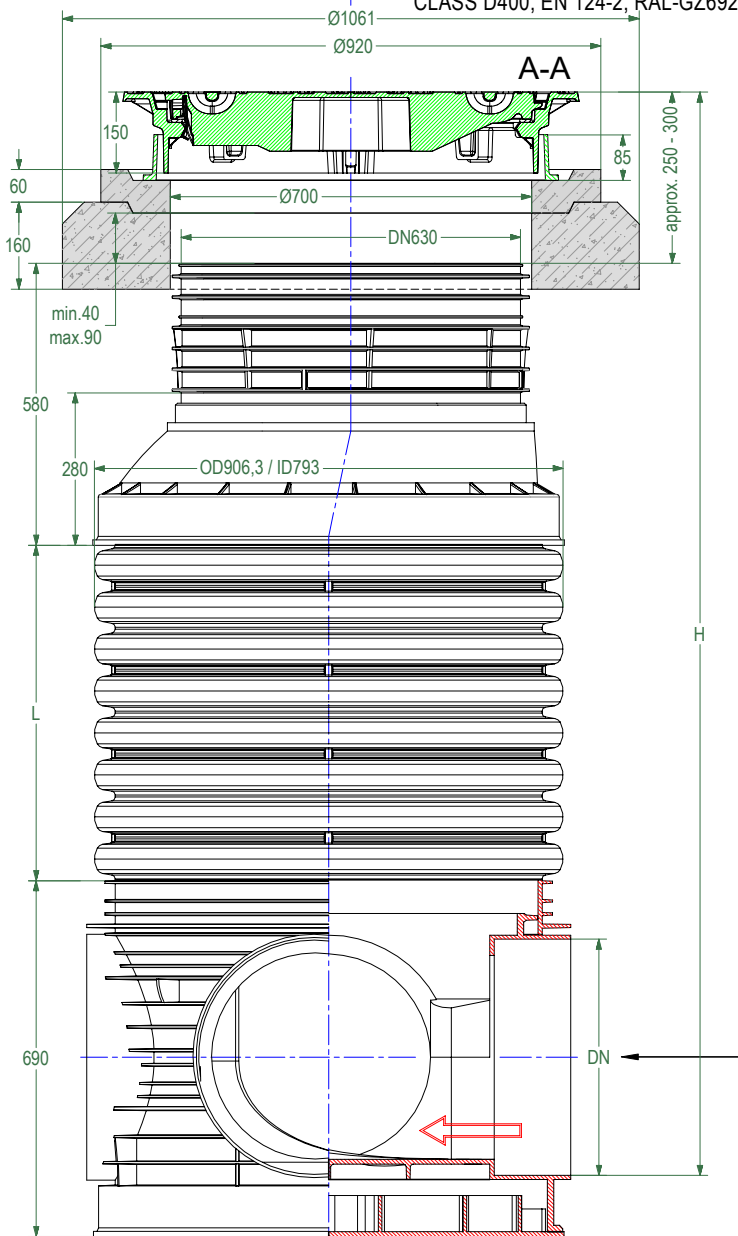

**IN270°**  
**OUT0° / IN90° / IN180° / IN270°**  
 DN110, 160, 200, 250, 315, 400 mm

DN/OD, EN 13476-2, EN 1852-1, EN 14758-1

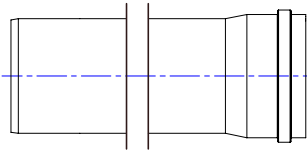

DN/OD, EN 13476-3

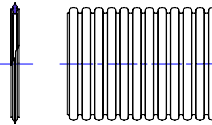

DN/ID, EN 13476-3

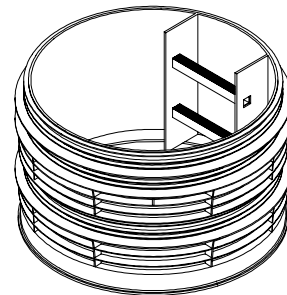
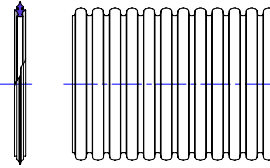

Chamber base connection type is modified according to your project to meet necessary requirements (smooth/corrugated pipe connection).

*This drawing is not suitable for the design and construction of other objects without the consent of SIA "EVOPIPES"*



SIA "EVOPIPES"  
 Langervaldes str. 2a, Jelgava, LV-3002, Latvia  
 Company reg. No.: 50003728871  
 Phone: +371 63094300  
 E-mail: [info@evopipes.lv](mailto:info@evopipes.lv)  
 Website: [www.evopipes.lv](http://www.evopipes.lv)

FILE NAME:  
 DN800.630.SL.G.3BL

SHEET: 1 OF 1

SHEET FORMAT: @ A4

SCALE:  
 WITHOUT SCALE

STAGE:  
 STANDARD DRAWING

DRAWING No.:	VERSION	REVISION	REVISION STATUS
DN800.630.SL.G	EN	1	ACTUAL

# DN800.630.SL.G

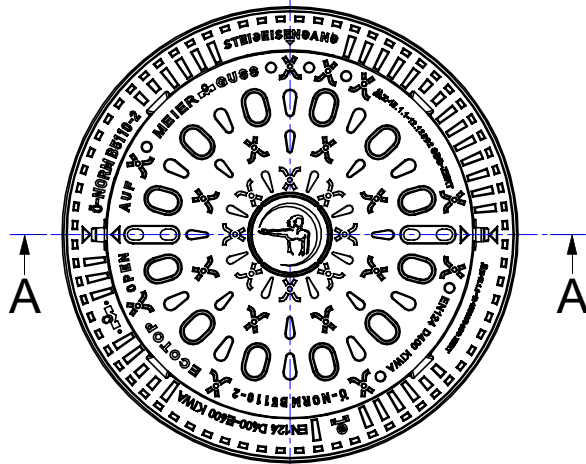

CLASS D400, EN 124-2, RAL-GZ692

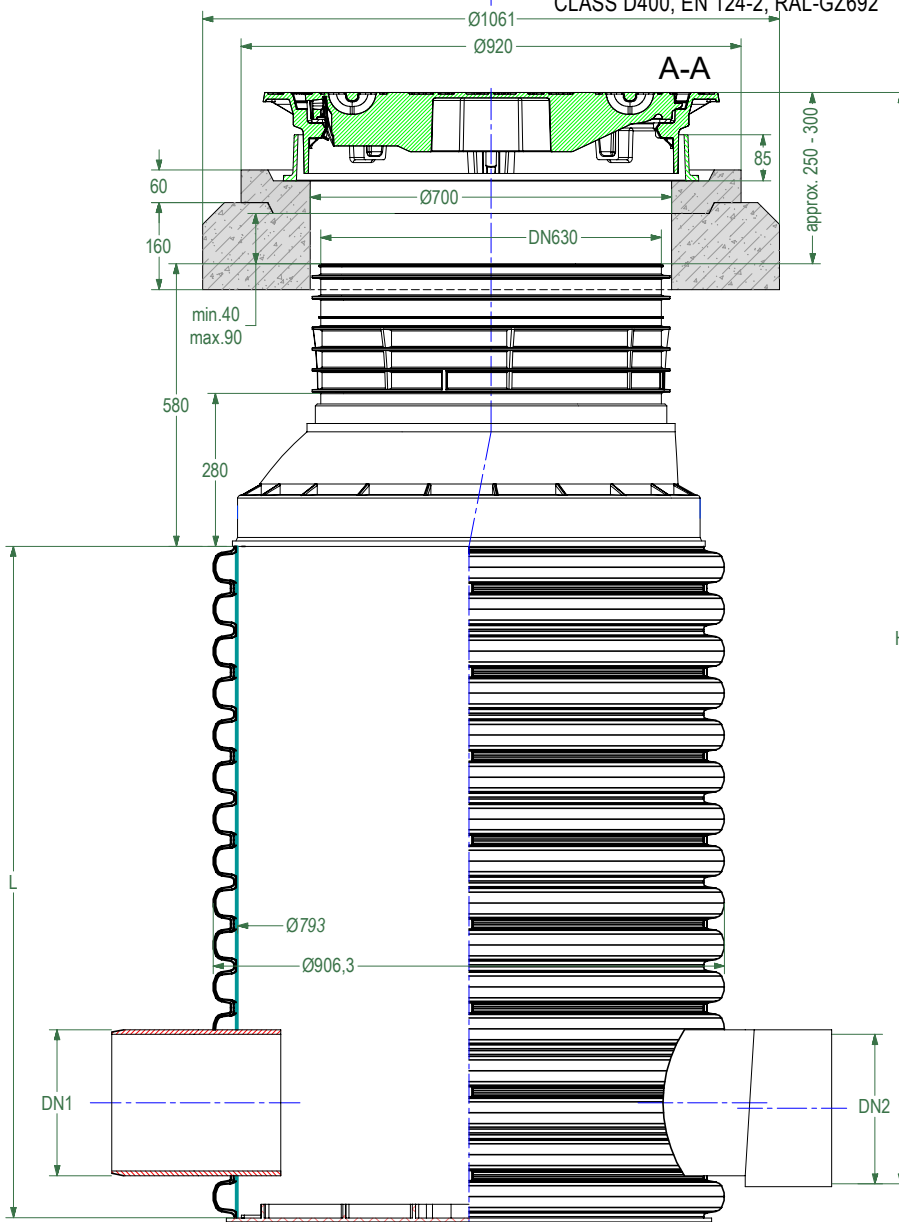

**DN1**  
DN/OD 110, 160, 200, 250, 315, 400 mm  
(EN 13476-2, EN 1852-1, EN 14758-1)

**DN2**  
DN/OD 160, 200, 250, 315, 400 mm (EN 13476-3)  
DN/ID 500 mm (EN 13476-3)

*This drawing is not suitable for the design and construction of other objects without the consent of SIA "EVOPIPES"*



SIA "EVOPIPES"  
Langervaldes str. 2a, Jelgava, LV-3002, Latvia  
Company reg. No.: 50003728871  
Phone: +371 63094300  
E-mail: [info@evopipes.lv](mailto:info@evopipes.lv)  
Website: [www.evopipes.lv](http://www.evopipes.lv)

FILE NAME:  
DN800.630.SL.G

SHEET: 1 OF 1

SHEET FORMAT: @ A4

SCALE:  
WITHOUT SCALE

STAGE:  
STANDARD DRAWING