

DN1000.625.SL.3BL

DRAWING No.:	VERSION	REVISION	REVISION STATUS
DN1000.625.SL.3BL	EN	1	ACTUAL

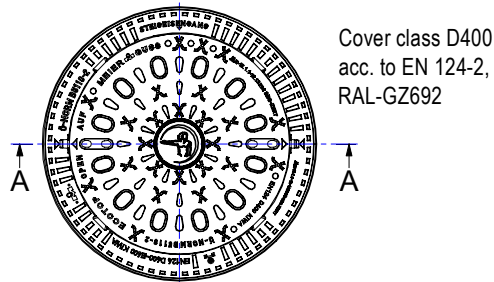

Cover class D400
acc. to EN 124-2,
RAL-GZ692

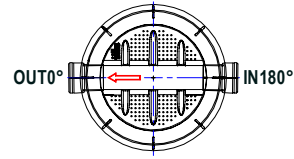

OUT0° / IN180°

DN160, 200, 250, 315, 400 mm

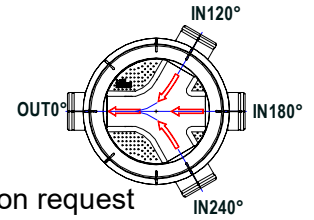
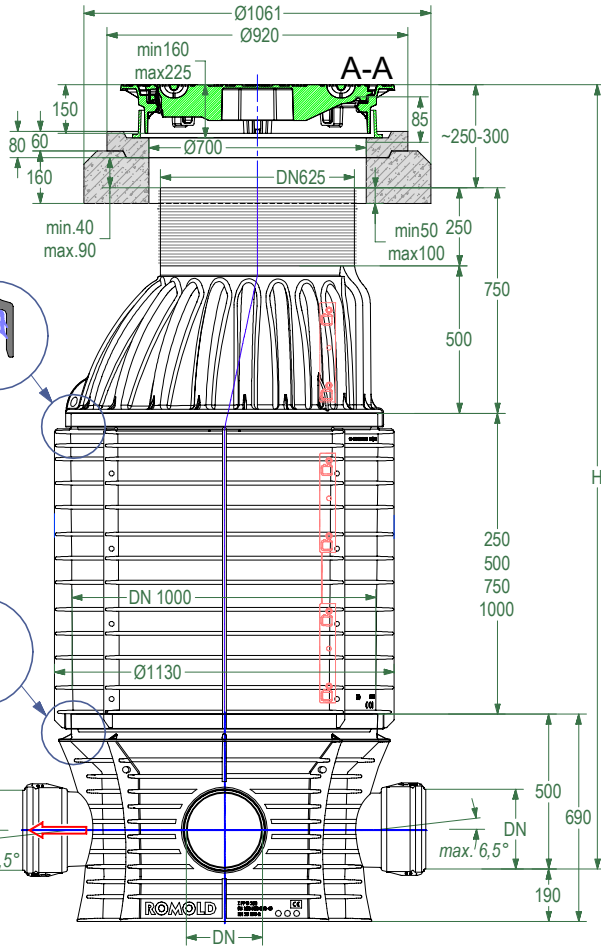

DN160 mm on request

OUT0° / IN120° / IN180° / IN240°

DN200, 250, 315 mm

RIGHT | LEFT

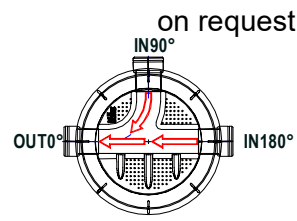

OUT0° / IN90° / IN180°
DN160, 200, 250, 315 mm

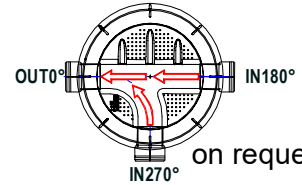

OUT0° / IN180° / IN270°
DN160, 200, 250, 315 mm

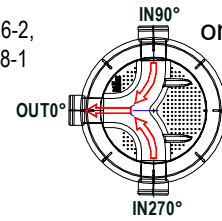

OUT0° / IN90° / IN270°
DN200, 250, 315 mm

RIGHT | LEFT

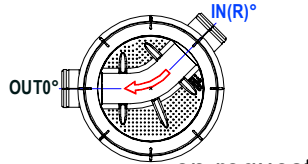

OUT0° / IN(R)°
DN160, 200, 250, 315, 400 mm

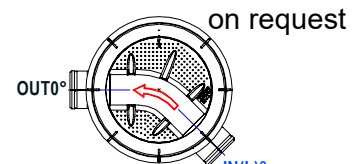

OUT0° / IN(L)°
DN160, 200, 250, 315, 400 mm

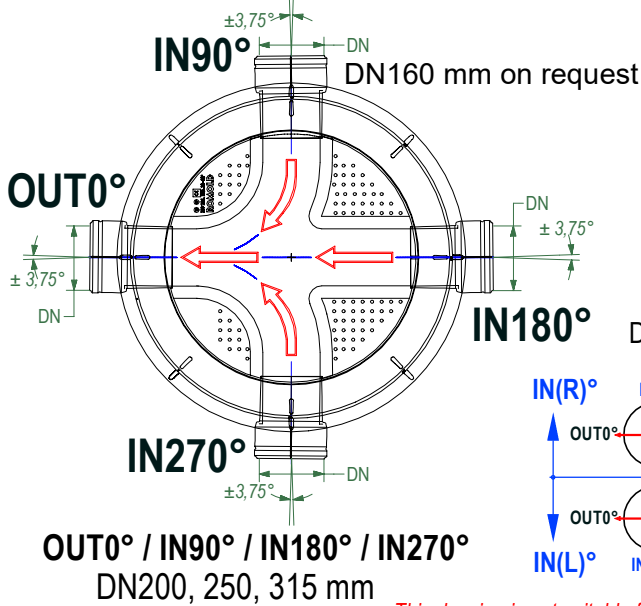

OUT0° / IN90° / IN180° / IN270°
DN200, 250, 315 mm

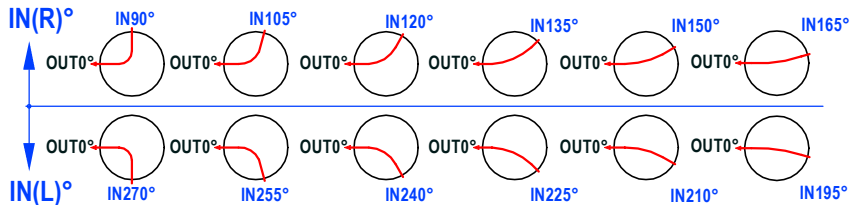

This drawing is not suitable for the design and construction of other objects without the consent of SIA "EVOPIPES"



SIA "EVOPIPES"
Langervaldes str. 2a, Jelgava, LV-3002, Latvia
Company reg. No.: 50003728871
Phone: +371 63094300
E-mail: info@evopipes.lv
Website: www.evopipes.lv

FILE NAME:
DN1000.625.SL.3BL

SHEET: 1 OF 1

SHEET FORMAT: @ A4

SCALE:
WITHOUT SCALE

STAGE:
STANDARD DRAWING

DN1000.625.SL.1B

DRAWING No.:	VERSION	REVISION	REVISION STATUS
DN1000.625.SL.1B	EN	1	ACTUAL

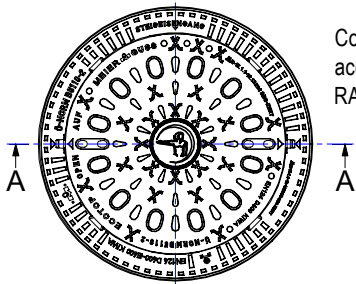

Cover class D400
acc. to EN 124-2,
RAL-GZ692

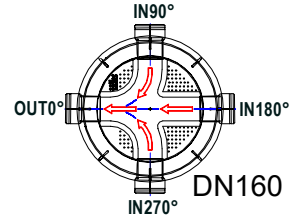

DN160 mm on request

OUT0° / IN90° / IN180° / IN270°
DN200, 250, 315 mm

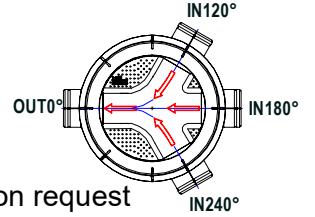

DN160 mm on request
OUT0° / IN120° / IN180° / IN240°
DN200, 250, 315 mm

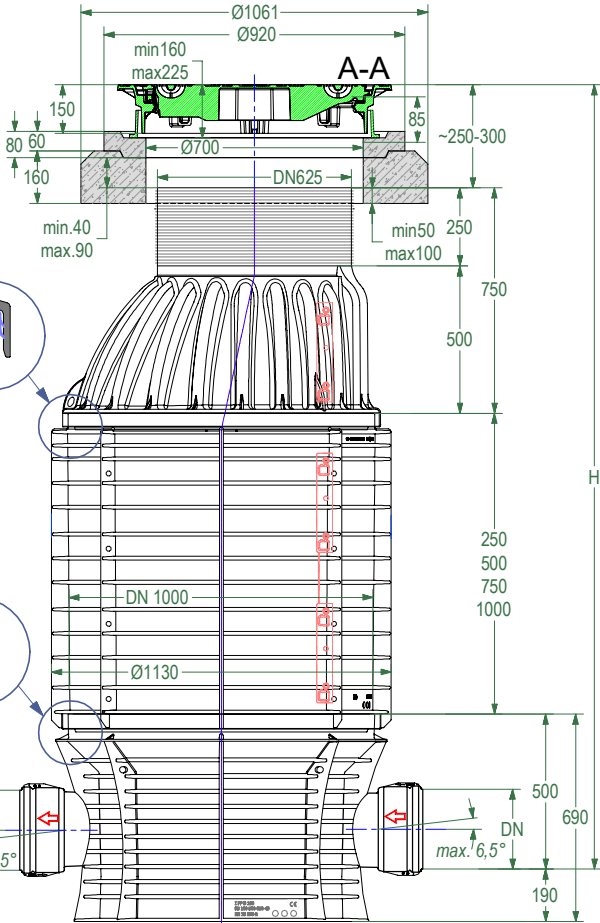

RIGHT | LEFT

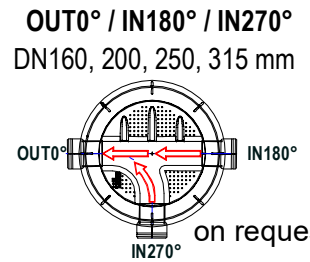
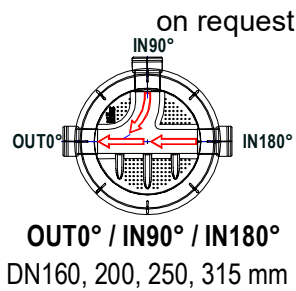

PP DN/OD, EN 13476-2,
EN 1852-1, EN 14758-1

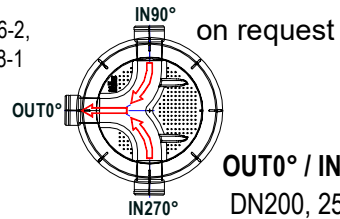

RIGHT | LEFT

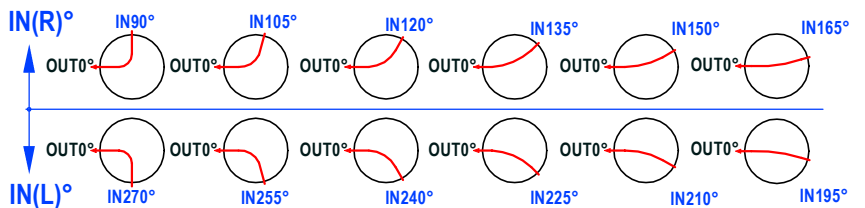
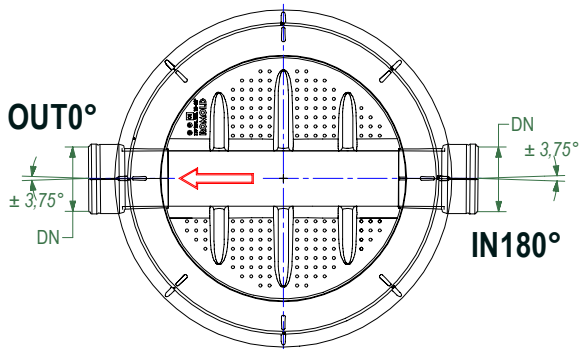
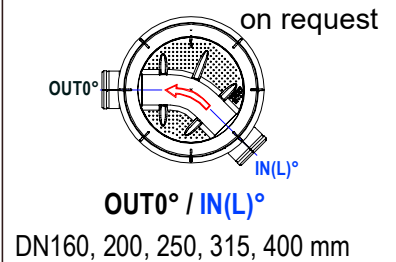
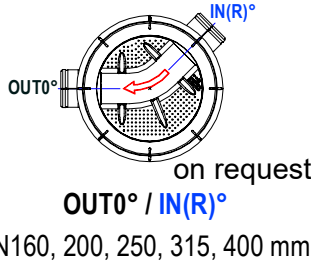

This drawing is not suitable for the design and construction of other objects without the consent of SIA "EVOPIPES"



SIA "EVOPIPES"
Langervaldes str. 2a, Jelgava, LV-3002, Latvia
Company reg. No.: 50003728871
Phone: +371 63094300
E-mail: info@evopipes.lv
Website: www.evopipes.lv

FILE NAME:
DN1000.625.SL.1B

SHEET: 1 OF 1

SHEET FORMAT: @ A4

SCALE:
WITHOUT SCALE

STAGE:
STANDARD DRAWING

DN1000.625.SL.3BL.PR

DRAWING No.:	VERSION	REVISION	REVISION STATUS
DN1000.625.SL.700.PR	EN	1	ACTUAL

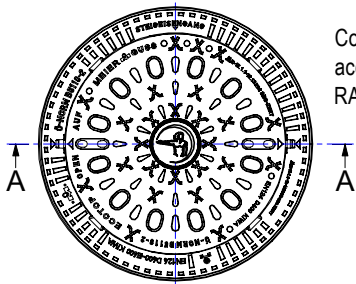

Cover class D400
acc. to EN 124-2,
RAL-GZ692

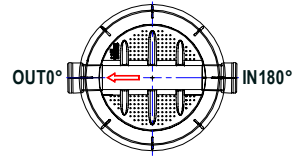

OUT0° / IN180°

DN160, 200, 250, 315, 400 mm

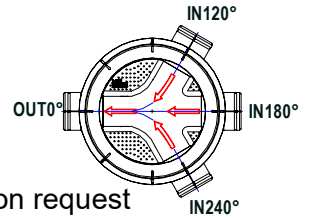

DN160 mm on request

OUT0° / IN120° / IN180° / IN240°

DN200, 250, 315 mm

RIGHT | LEFT

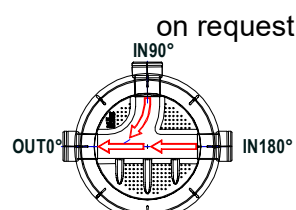

OUT0° / IN90° / IN180°
DN160, 200, 250, 315 mm

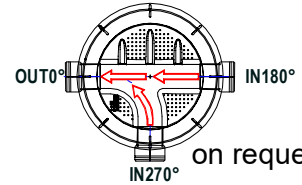

OUT0° / IN180° / IN270°
DN160, 200, 250, 315 mm

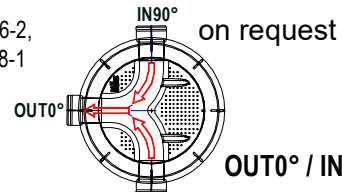

OUT0° / IN90° / IN270°
DN200, 250, 315 mm

RIGHT | LEFT

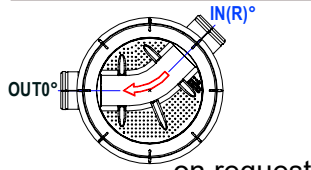

OUT0° / IN(R)°
DN160, 200, 250, 315, 400 mm

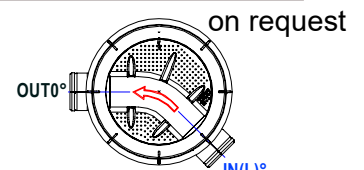

OUT0° / IN(L)°
DN160, 200, 250, 315, 400 mm

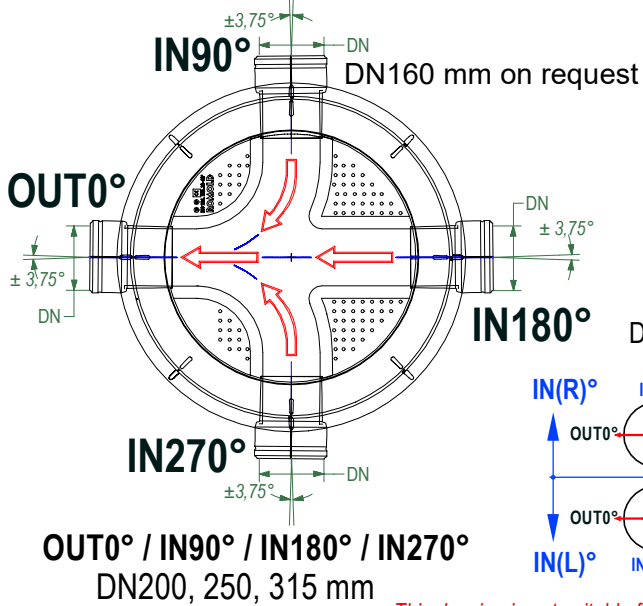
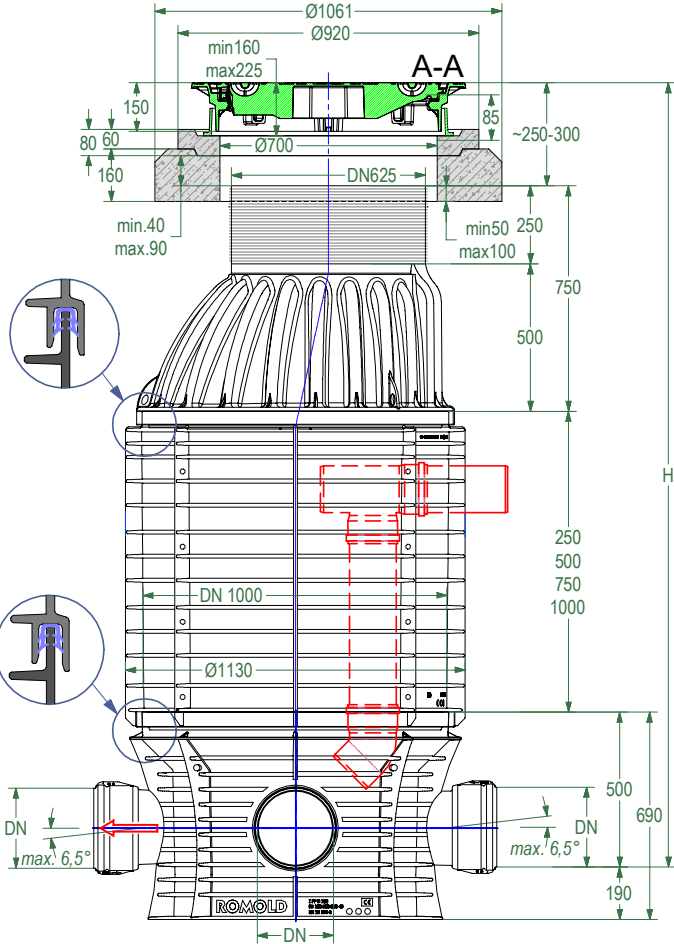
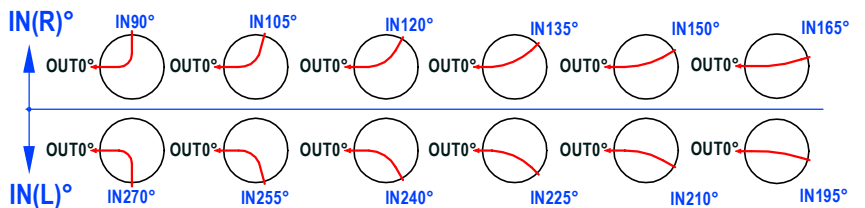

This drawing is not suitable for the design and construction of other objects without the consent of SIA "EVOPIPES"



SIA "EVOPIPES"
Langervaldes str. 2a, Jelgava, LV-3002, Latvia
Company reg. No.: 50003728871
Phone: +371 63094300
E-mail: info@evopipes.lv
Website: www.evopipes.lv

FILE NAME:
DN1000.625.SL.700.PR

SHEET: 1 OF 1

SHEET FORMAT: @ A4

SCALE:
WITHOUT SCALE

STAGE:
STANDARD DRAWING

DN1000.625.SL.1B.PR

DRAWING No.:	VERSION	REVISION	REVISION STATUS
DN1000.625.SL.700.PR	EN	1	ACTUAL

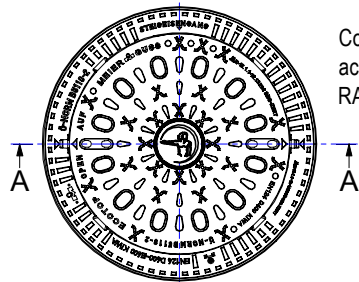

Cover class D400
acc. to EN 124-2,
RAL-GZ692

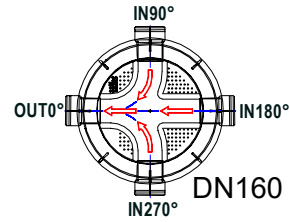
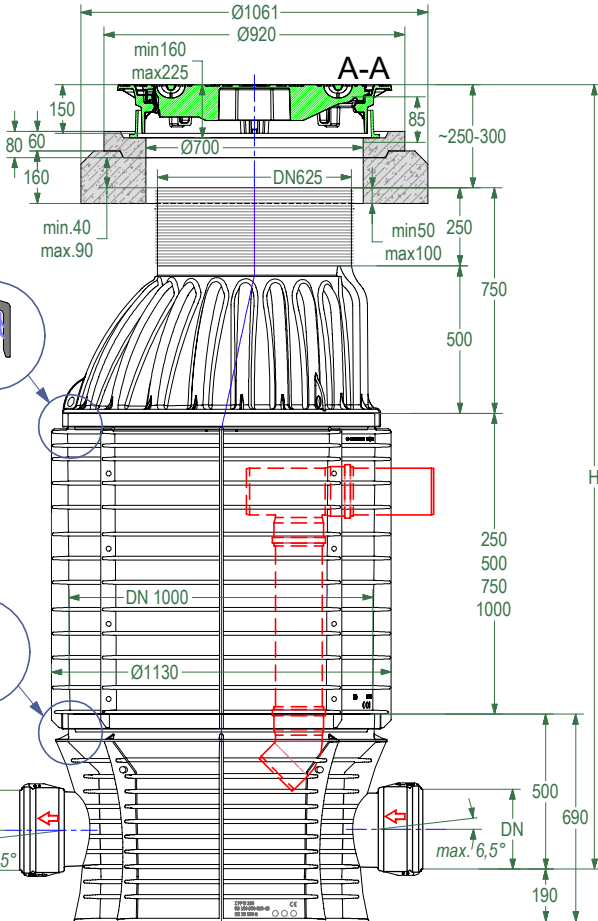

OUT0° / IN90° / IN180° / IN270°
DN200, 250, 315 mm

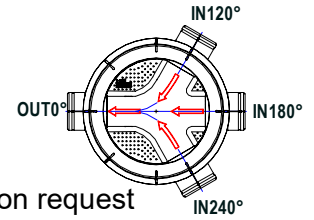

DN160 mm on request
OUT0° / IN120° / IN180° / IN240°
DN200, 250, 315 mm

RIGHT | LEFT

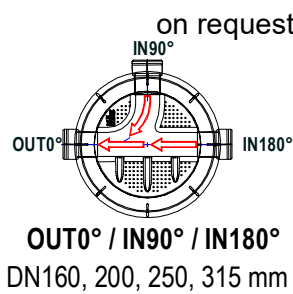

OUT0° / IN180° / IN270°
DN160, 200, 250, 315 mm

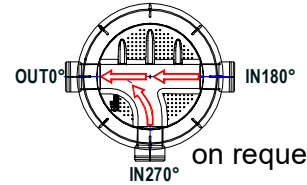

PP DN/OD, EN 13476-2,
EN 1852-1, EN 14758-1

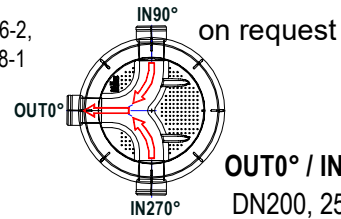

OUT0° / IN90° / IN270°
DN200, 250, 315 mm

RIGHT | LEFT

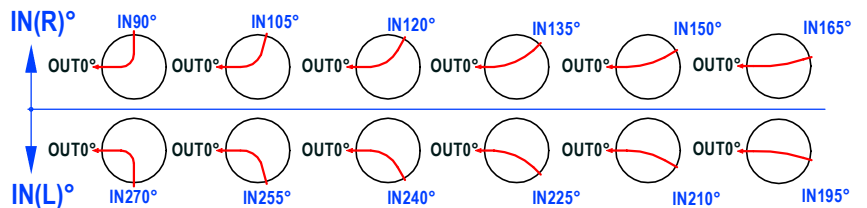
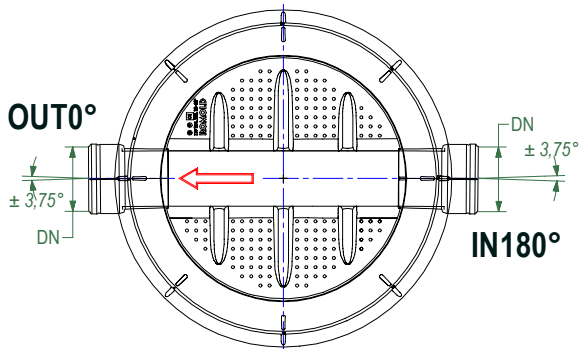
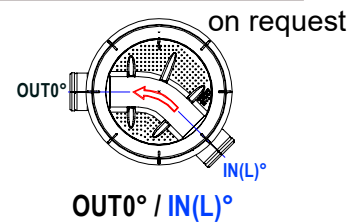
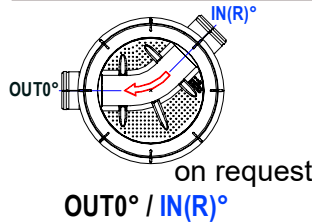

This drawing is not suitable for the design and construction of other objects without the consent of SIA "EVOPIPES"



SIA "EVOPIPES"
Langervaldes str. 2a, Jelgava, LV-3002, Latvia
Company reg. No.: 50003728871
Phone: +371 63094300
E-mail: info@evopipes.lv
Website: www.evopipes.lv

FILE NAME:
DN1000.625.SL.700.PR

SHEET: 1 OF 1

SHEET FORMAT: @ A4

SCALE:
WITHOUT SCALE

STAGE:
STANDARD DRAWING