

| DRAWING No.: | VERSION | REVISION | REVISION STATUS |
|---------------------|---------|----------|-----------------|
| DN1000.625.G.SL.3BL | EN | 1 | ACTUAL |

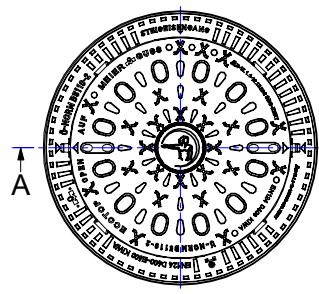

Cover class D400
acc. to EN 124-2,
RAL-GZ692

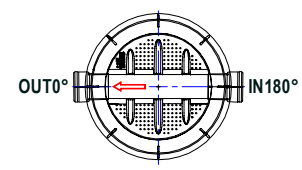
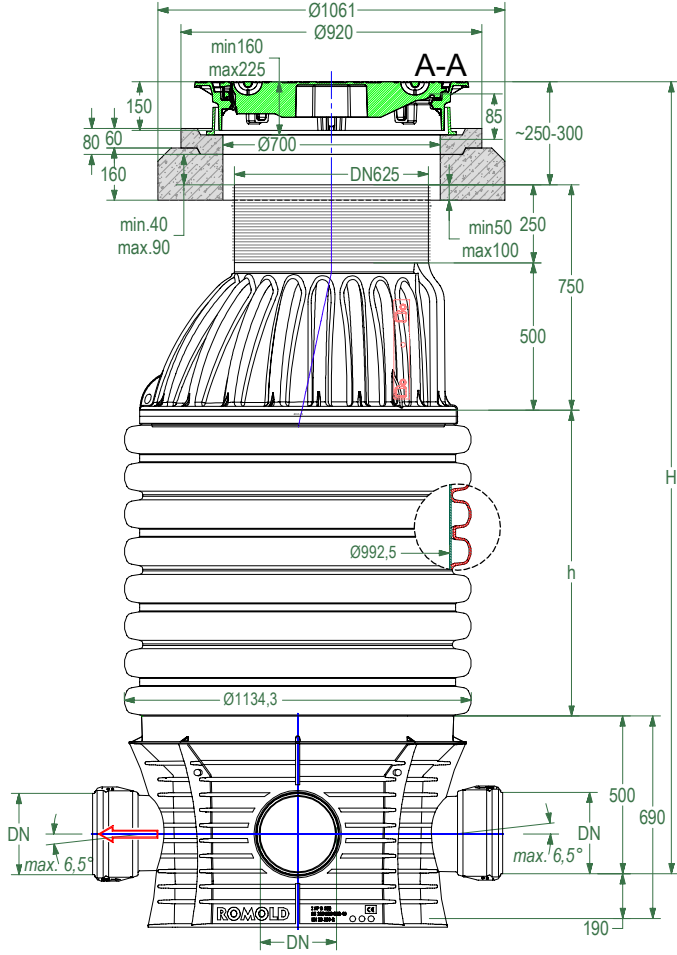

OUT0° / IN180°
DN160, 200, 250, 315, 400 mm

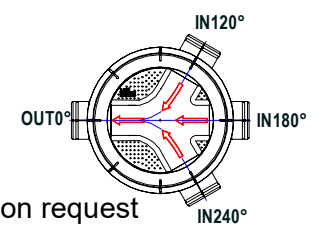

DN160 mm on request
OUT0° / IN120° / IN180° / IN240°
DN200, 250, 315 mm

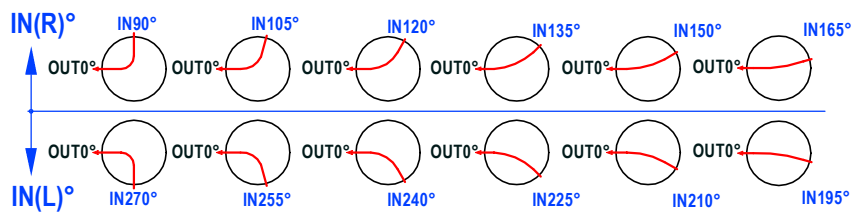
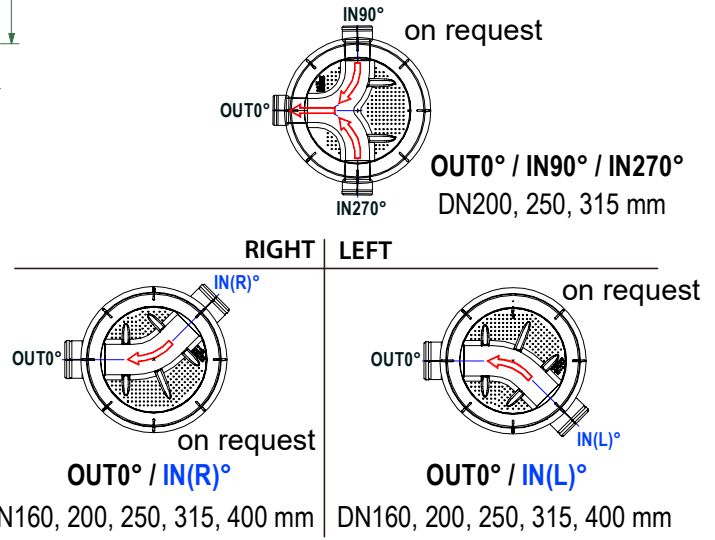
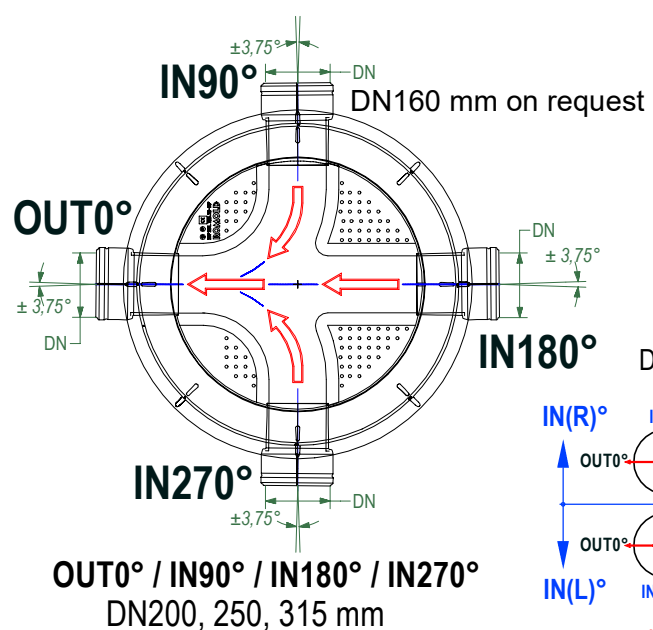
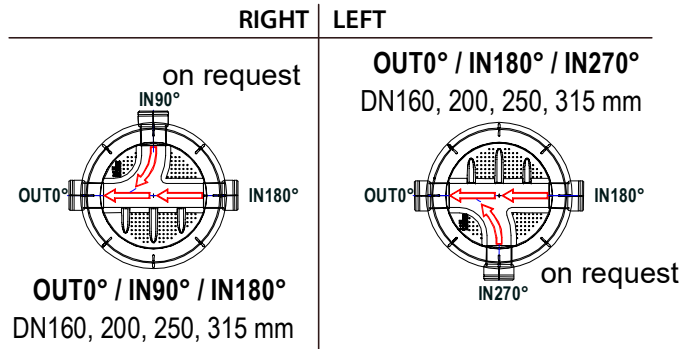

This drawing is not suitable for the design and construction of other objects without the consent of SIA "EVOPIPES"



SIA "EVOPIPES"
Langervaldes str. 2a, Jelgava, LV-3002, Latvia
Company reg. No.: 50003728871
Phone: +371 63094300
E-mail: info@evopipes.lv
Website: www.evopipes.lv

FILE NAME:
DN1000.625.G.SL.3BL

SHEET: 1 OF 1

SHEET FORMAT: @ A4

SCALE:
WITHOUT SCALE

STAGE:
STANDARD DRAWING

| DRAWING No.: | VERSION | REVISION | REVISION STATUS |
|--------------------|---------|----------|-----------------|
| DN1000.625.G.SL.1B | EN | 1 | ACTUAL |

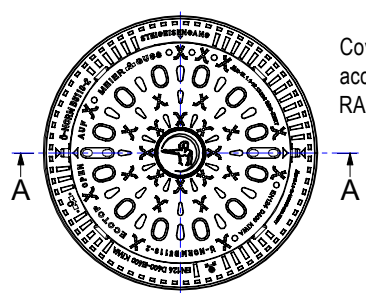

Cover class D400
acc. to EN 124-2,
RAL-GZ692

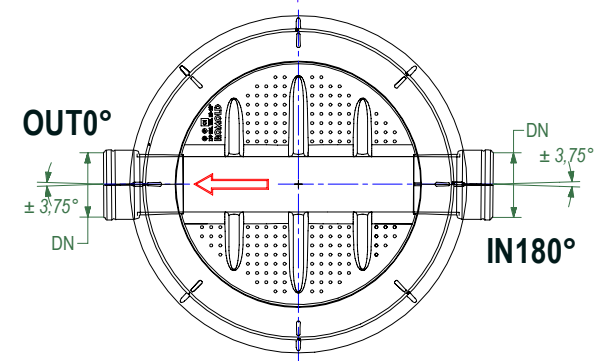
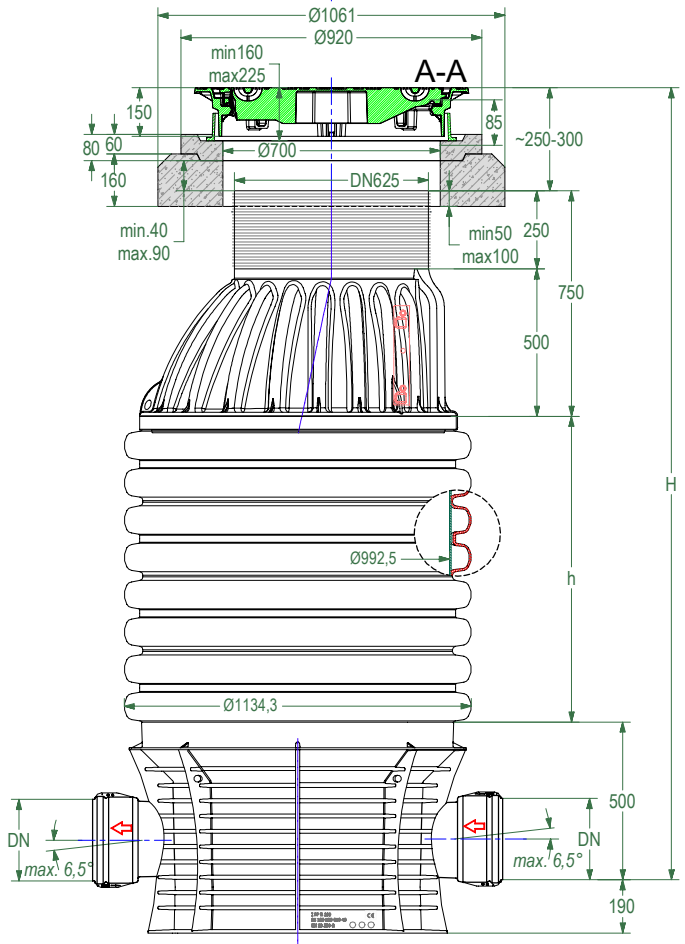

OUT0° / IN180°
DN160, 200, 250, 315, 400 mm

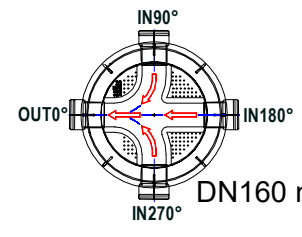

DN160 mm on request
OUT0° / IN90° / IN180° / IN270°
DN200, 250, 315 mm

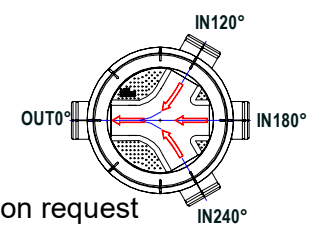

DN160 mm on request
OUT0° / IN120° / IN180° / IN240°
DN200, 250, 315 mm

RIGHT | LEFT

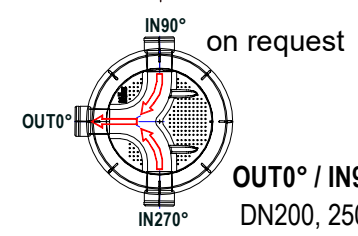
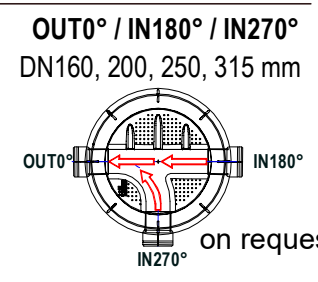
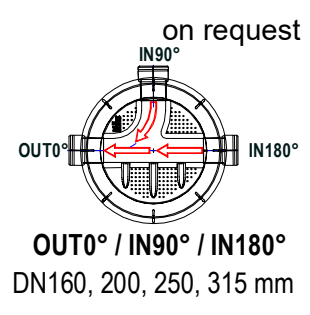

RIGHT | LEFT

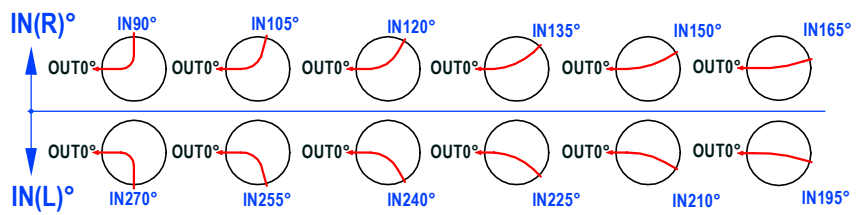
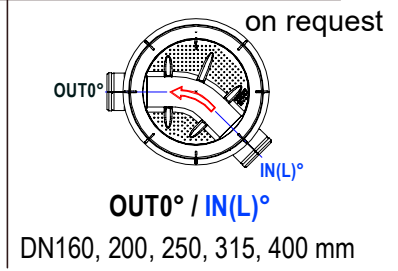
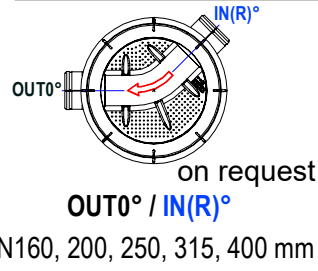

This drawing is not suitable for the design and construction of other objects without the consent of SIA "EVOPIPES"



SIA "EVOPIPES"
Langervaldes str. 2a, Jelgava, LV-3002, Latvia
Company reg. No.: 50003728871
Phone: +371 63094300
E-mail: info@evopipes.lv
Website: www.evopipes.lv

FILE NAME:
DN1000.625.G.SL.1B

SHEET: 1 OF 1

SHEET FORMAT: @ A4

SCALE:
WITHOUT SCALE

STAGE:
STANDARD DRAWING

| DRAWING No.: | VERSION | REVISION | REVISION STATUS |
|--------------------|---------|----------|-----------------|
| DN1000.625.G.S.3BL | EN | 1 | ACTUAL |

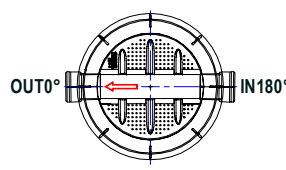
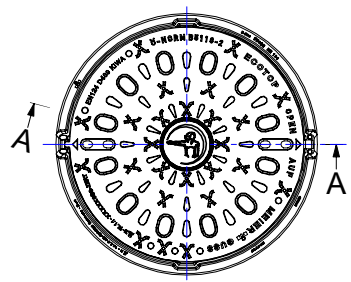

OUT0° / IN180°
DN160, 200, 250, 315, 400 mm

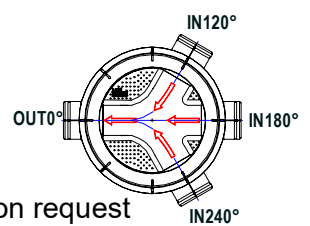
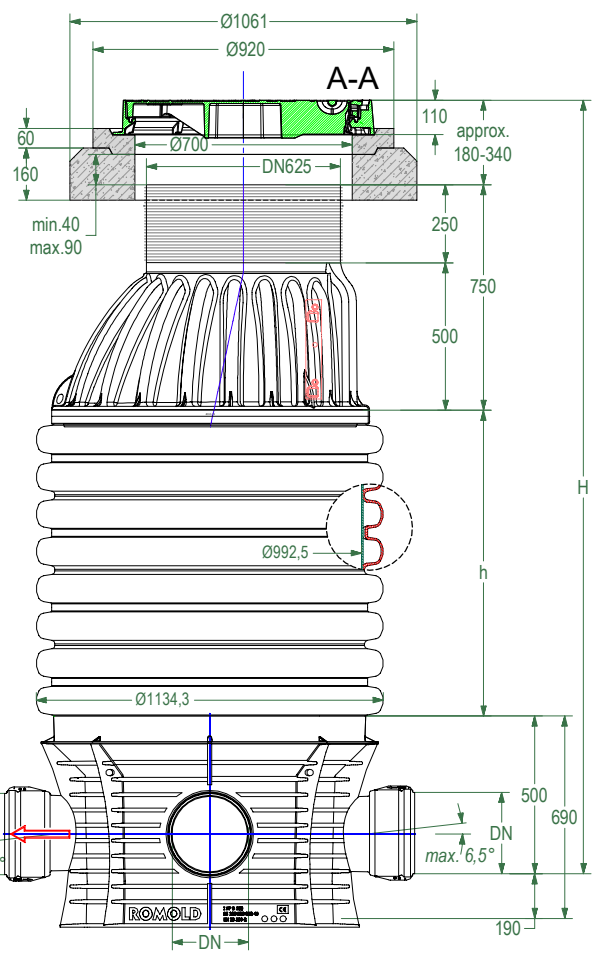

OUT0° / IN120° / IN180° / IN240°
DN200, 250, 315 mm

RIGHT | LEFT

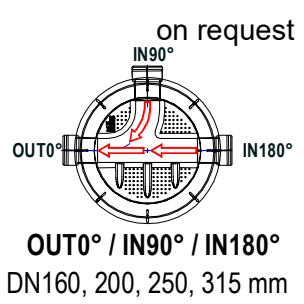

OUT0° / IN90° / IN180°
DN160, 200, 250, 315 mm

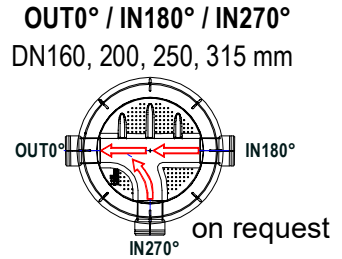

OUT0° / IN180° / IN270°
DN160, 200, 250, 315 mm

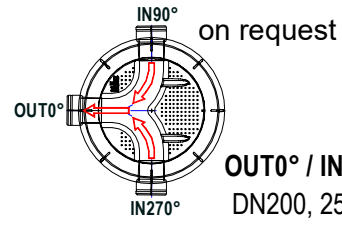

OUT0° / IN90° / IN270°
DN200, 250, 315 mm

RIGHT | LEFT

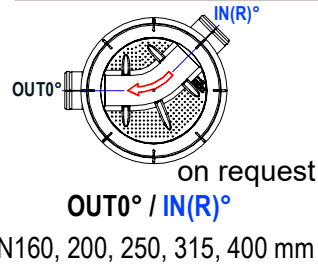

OUT0° / IN(R)°
DN160, 200, 250, 315, 400 mm

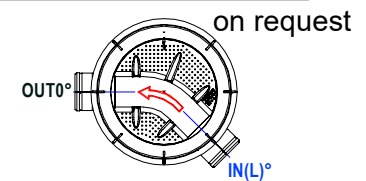

OUT0° / IN(L)°
DN160, 200, 250, 315, 400 mm

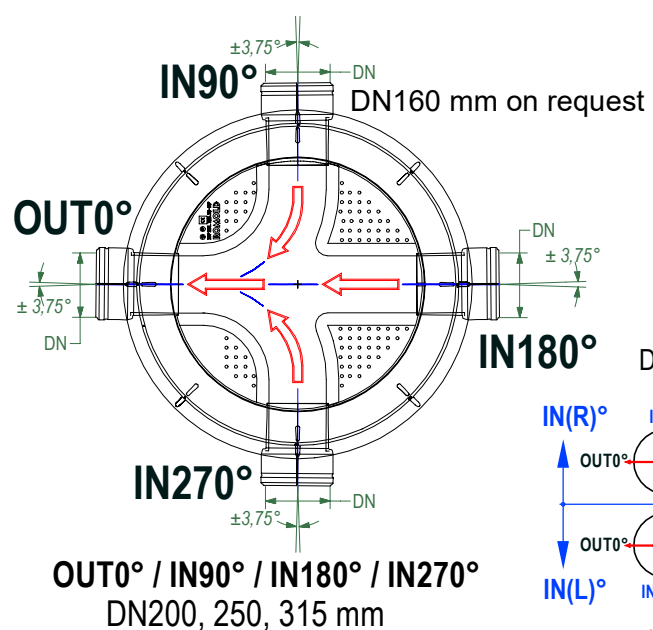

OUT0° / IN90° / IN180° / IN270°
DN200, 250, 315 mm

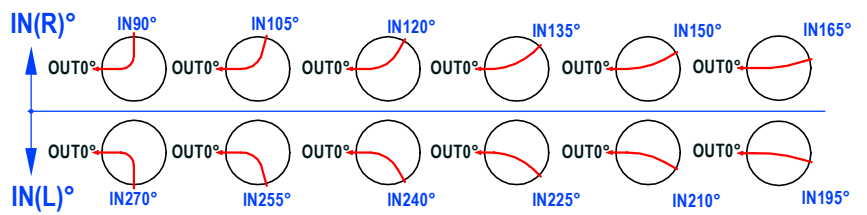

This drawing is not suitable for the design and construction of other objects without the consent of SIA "EVOPIPES"



SIA "EVOPIPES"
Langervaldes str. 2a, Jelgava, LV-3002, Latvia
Company reg. No.: 50003728871
Phone: +371 63094300
E-mail: info@evopipes.lv
Website: www.evopipes.lv

FILE NAME:
DN1000.625.G.S.3BL

SHEET: 1 OF 1

SHEET FORMAT: @ A4

SCALE:
WITHOUT SCALE

STAGE:
STANDARD DRAWING

| DRAWING No.: | VERSION | REVISION | REVISION STATUS |
|-------------------|---------|----------|-----------------|
| DN1000.625.G.S.1B | EN | 1 | ACTUAL |

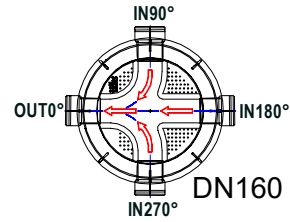
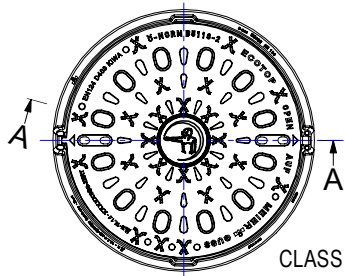

OUT0° / IN90° / IN180° / IN270°
DN200, 250, 315 mm

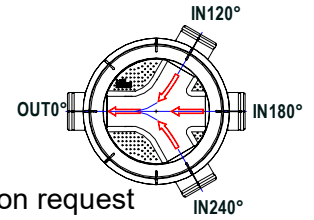
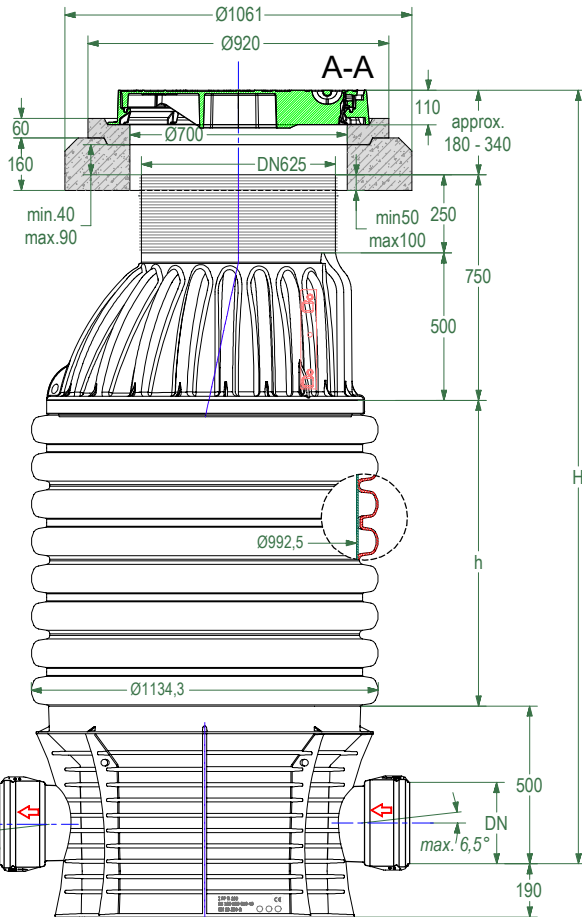

OUT0° / IN120° / IN180° / IN240°
DN200, 250, 315 mm

RIGHT | LEFT

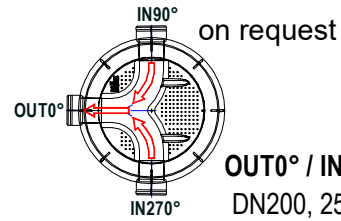
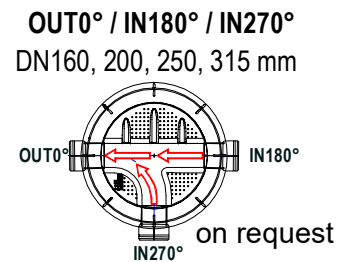
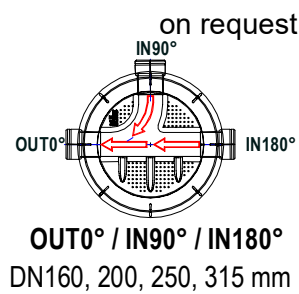

RIGHT | LEFT

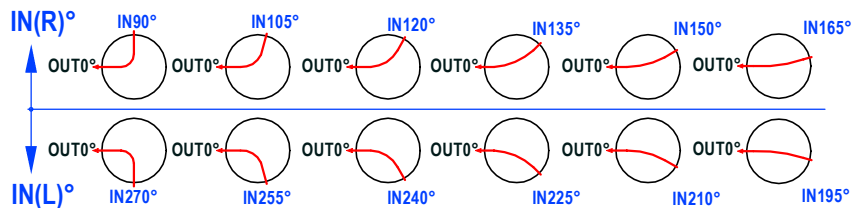
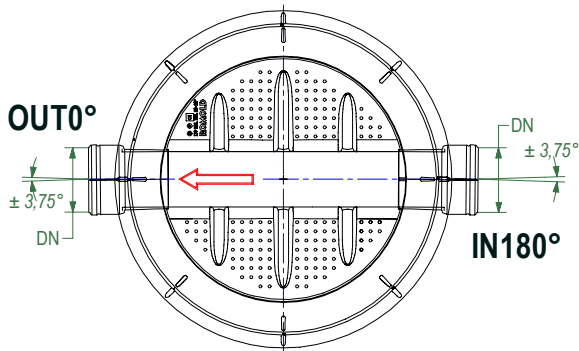
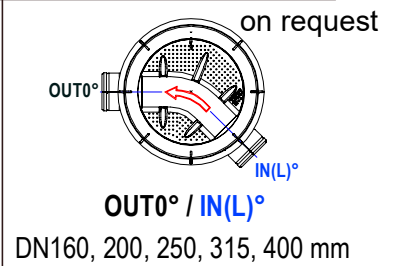
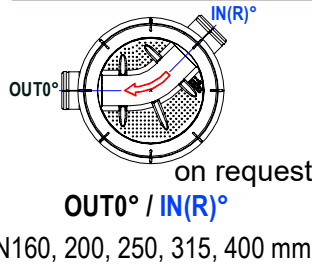

This drawing is not suitable for the design and construction of other objects without the consent of SIA "EVOPIPES"



SIA "EVOPIPES"
Langervaldes str. 2a, Jelgava, LV-3002, Latvia
Company reg. No.: 50003728871
Phone: +371 63094300
E-mail: info@evopipes.lv
Website: www.evopipes.lv

FILE NAME:
DN1000.625.G.S.1B

SHEET: 1 OF 1

SHEET FORMAT: @ A4

SCALE:
WITHOUT SCALE

STAGE:
STANDARD DRAWING