

# DN600.500.1B

DRAWING No.:	VERSION	REVISION	REVISION STATUS
DN600.500.1B.3BL.1C	EN	1	ACTUAL

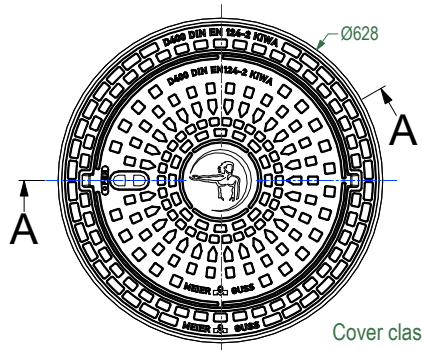

Cover class D400  
acc. to EN 124-2

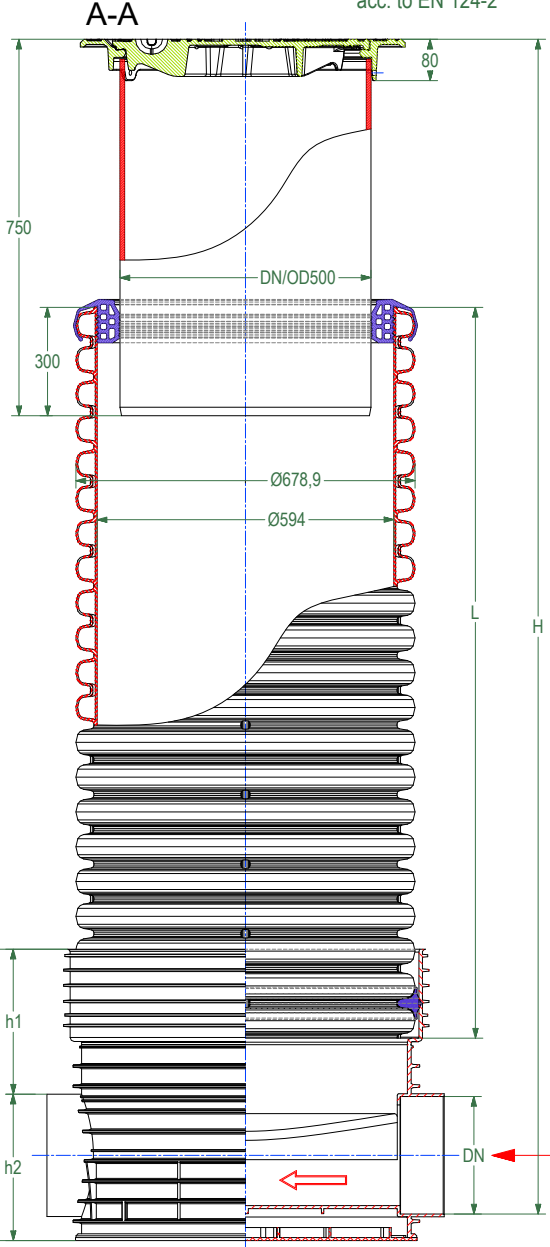

## DN600 BASE, TYPE 1B

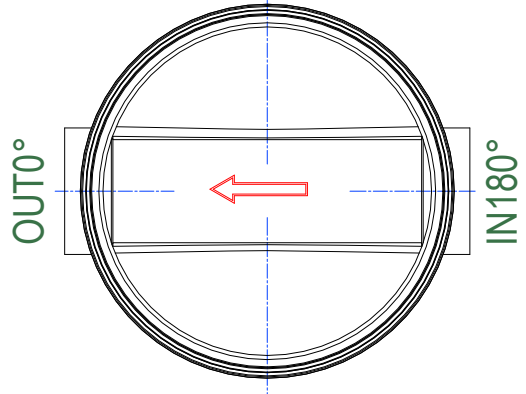

OUT0° / IN180°  
DN/ID 200, 250, 300 mm  
DN/OD 160, 200, 250, 315 mm

PP DN/OD, EN 13476-2,  
EN 1852-1, EN 14758-1

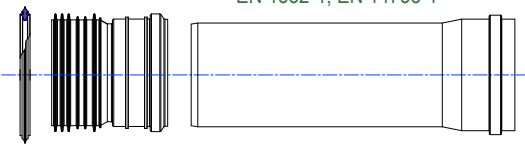

PP DN/OD, EN 13476-3

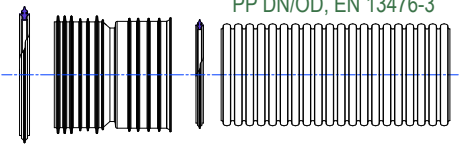

PP DN/ID, EN 13476-3

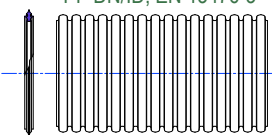

OUT0° / IN180°	h1	h2	H1
mm	mm	mm	mm
DN 160	267	289	556
DN 200	267	289	556
DN 250	236	320	556
DN 315	180	376	556

*This drawing is the property of SIA Evopipes and is protected by law.*



SIA "EVOPIPES"  
Langervaldes str. 2a, Jelgava, LV-3002, Latvia  
Company reg. No.: 50003728871  
Phone: +371 63094300  
E-mail: [info@evopipes.lv](mailto:info@evopipes.lv)  
Website: [www.evopipes.lv](http://www.evopipes.lv)

FILE NAME:  
DN600.500.1B.3BL.1C  
SHEET: 1 OF 1

SHEET FORMAT: @A4

SCALE:  
WITHOUT SCALE  
STAGE:  
STANDARD DRAWING

# DN600.500.3BL

Cover class D400  
acc. to EN 124-2

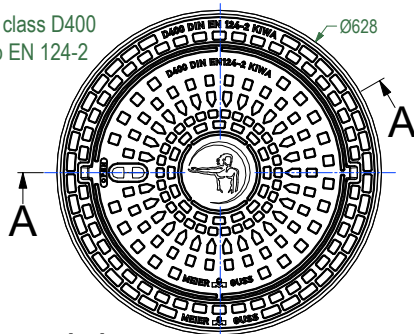

A-A

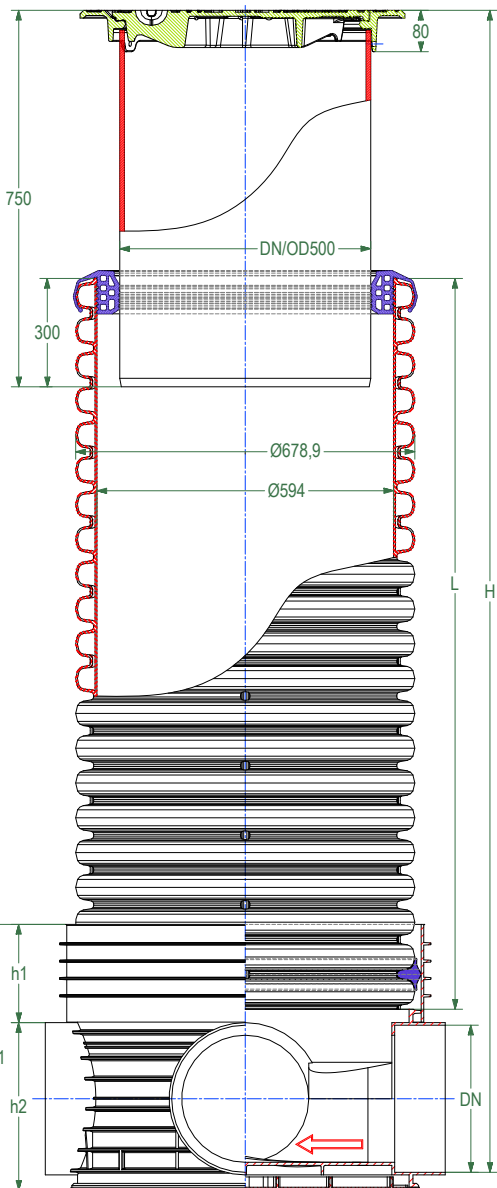

Chamber base DN600, type 3BL

OUT0° / IN90° / IN180° / IN270°	h1	h2	H1
mm	mm	mm	mm
DN 160	267	289	556
DN 200	267	289	556
DN 250	236	320	556

## DN600 BASE, TYPE 3BL

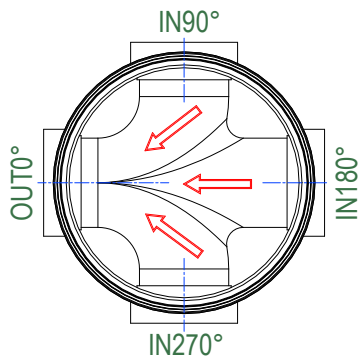

OUT0° / IN90° / IN180° / IN270°  
DN/ID 200, 250, 300 mm  
DN/OD 160, 200, 250, 315 mm

## DN600 BASE, TYPE 2BT

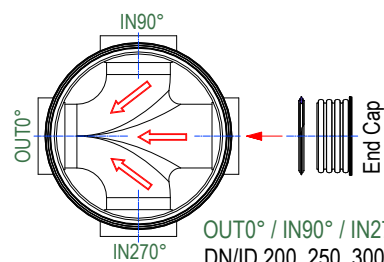

OUT0° / IN90° / IN270°  
DN/ID 200, 250, 300 mm  
DN/OD 160, 200, 250, 315 mm

## DN600 BASE, TYPE 1BB

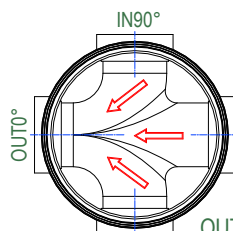

OUT0° / IN90°  
DN/ID 200, 250, 300 mm  
DN/OD 160, 200, 250, 315 mm

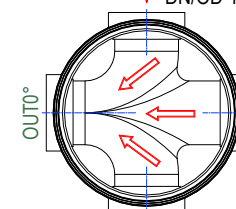

OUT0° / IN270°  
DN/ID 200, 250, 300 mm  
DN/OD 160, 200, 250, 315 mm

## DN600 BASE, TYPE 2BL

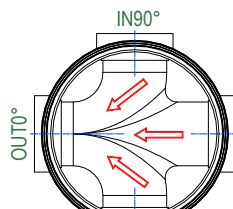

OUT0° / IN90° / IN180°  
DN/ID 200, 250, 300 mm  
DN/OD 160, 200, 250, 315 mm

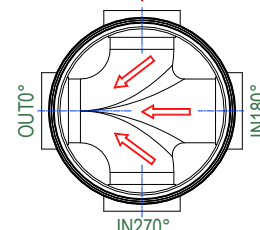

OUT0° / IN180° / IN270°  
DN/ID 200, 250, 300 mm  
DN/OD 160, 200, 250, 315 mm

PP DN/OD, EN 13476-2,  
EN 1852-1, EN 14758-1

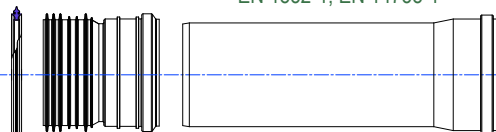

PP DN/ID, EN 13476-3

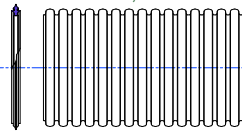

PP DN/OD, EN 13476-3

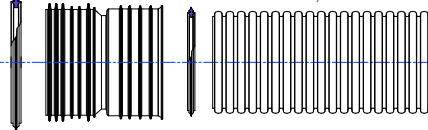

### NOTE:

By using 3BL type base and end cap(s) it is possible to achieve 1BB, 2BL, 2BT type base configuration.

*This drawing is the property of SIA Evopipes and is protected by law.*



SIA "EVOPIPES"  
Langervaldes str. 2a, Jelgava, LV-3002, Latvia  
Company reg. No.: 50003728871  
Phone: +371 63094300  
E-mail: [info@evopipes.lv](mailto:info@evopipes.lv)  
Website: [www.evopipes.lv](http://www.evopipes.lv)

FILE NAME:  
DN600.500.1B.3BL.1C

SHEET: 1 OF 1

SHEET FORMAT: @A4

SCALE:

WITHOUT SCALE

STAGE:

STANDARD DRAWING

DRAWING No.:	VERSION	REVISION	REVISION STATUS
DN600.500.1B.3BL.1C	EN	1	ACTUAL

# DN600.500.1C

## DN600 BASE, TYPE 1C

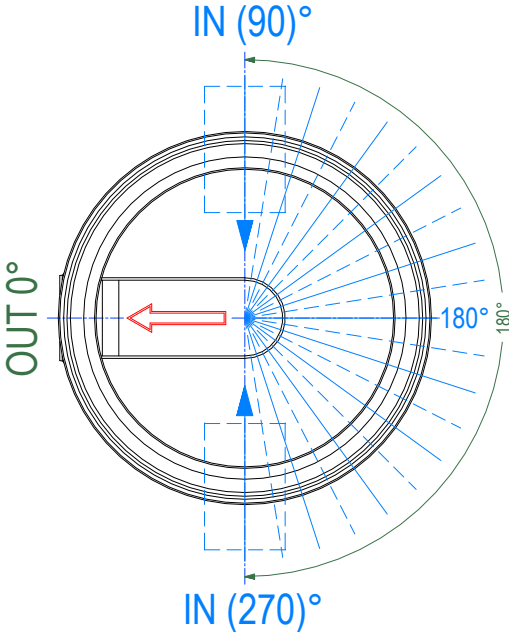

OUT 0° / IN(90 - 270°)  
 DN160, 200, 250, 315 mm  
 IN - requested connection in desirable angle

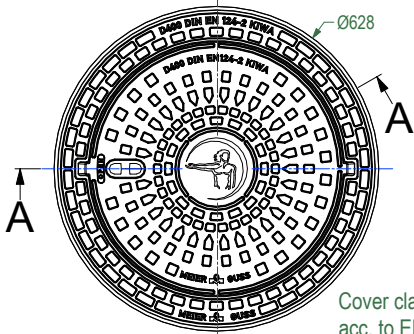

Cover class D400 acc. to EN 124-2

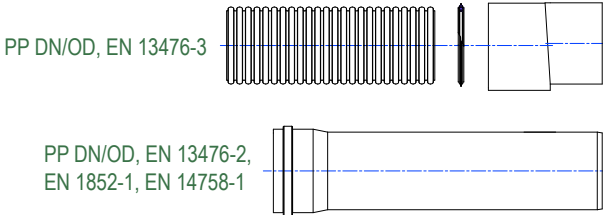
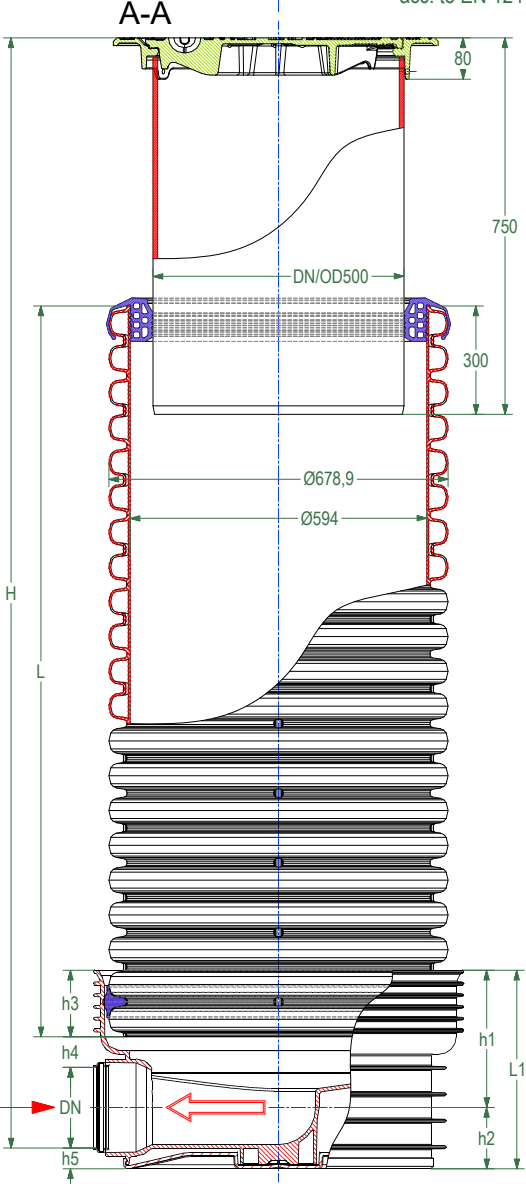

Chamber base DN600, type 1C						
OUT0° / IN (90-270)°	h1	h2	h3	h4	h5	L1
mm	mm	mm	mm	mm	mm	mm
DN160	272	121	158	33	41	393
DN200	293	142	158	33	41	435
DN250	319	168	158	34	42	487
DN315	353	203	158	36	44	556

*This drawing is the property of SIA Evopipes and is protected by law.*



SIA "EVOPIPES"  
 Langervaldes str. 2a, Jelgava, LV-3002, Latvia  
 Company reg. No.: 50003728871  
 Phone: +371 63094300  
 E-mail: [info@evopipes.lv](mailto:info@evopipes.lv)  
 Website: [www.evopipes.lv](http://www.evopipes.lv)

FILE NAME:  
 DN600.500.1B.3BL.1C

SHEET: 1 OF 1

SHEET FORMAT: @A4

SCALE:  
 WITHOUT SCALE  
 STAGE:  
 STANDARD DRAWING