

NOTE:

By using 3BL type base and end cap(s) it is possible to achieve 1BB, 2BL, 2BT type base configuration.

DN800.630.3BL

The chamber cover type (self-leveling or stationary) and load class must be selected according to the needs of the project. See www.evopipes.com for possible chamber cover solutions in the Products section - Chamber covers, grates and support rings.

DN800 BASE, TYPE 3BL

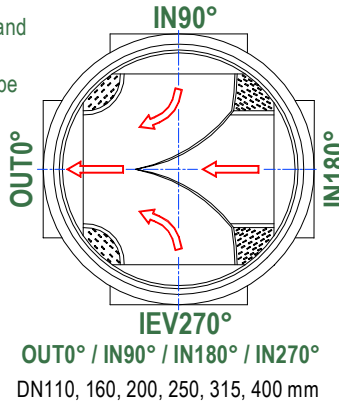

DN800 BASE, TYPE 2BT

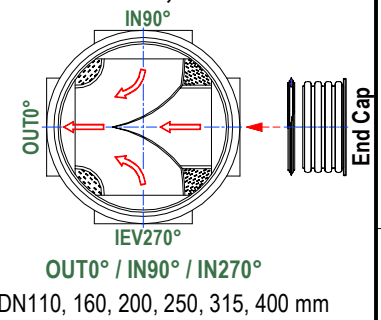

DN800 BASE, TYPE 1BB

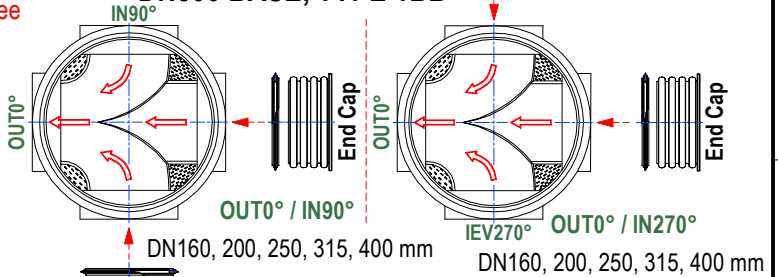

DN800 BASE, TYPE 2BL

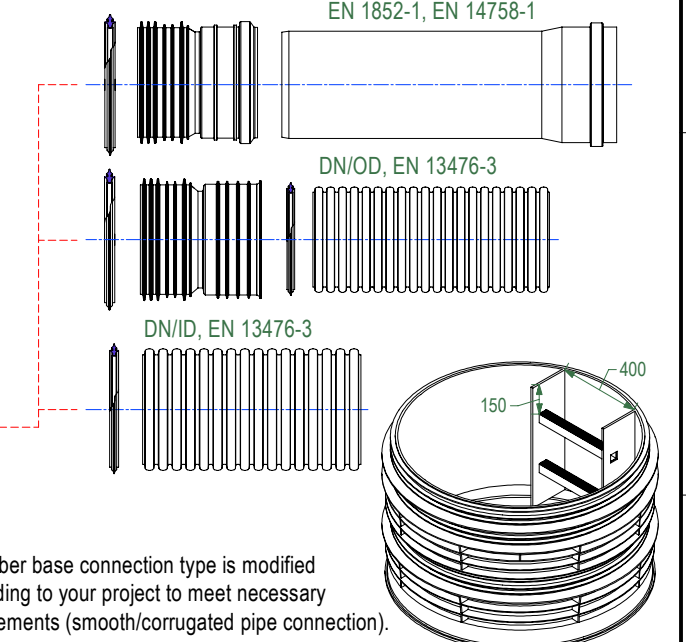
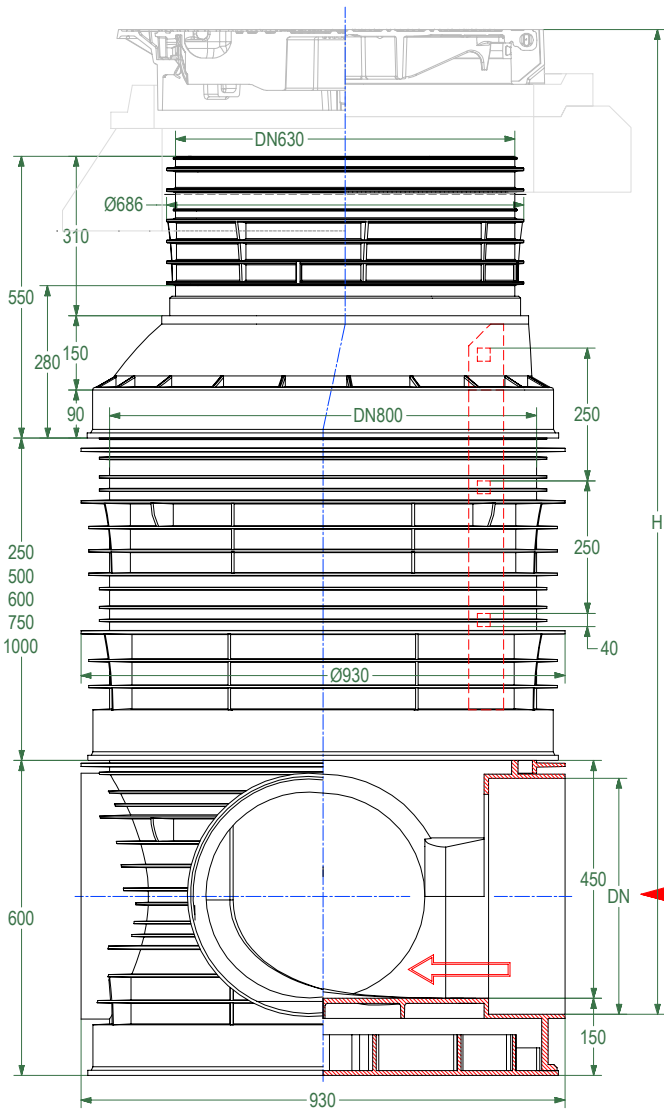
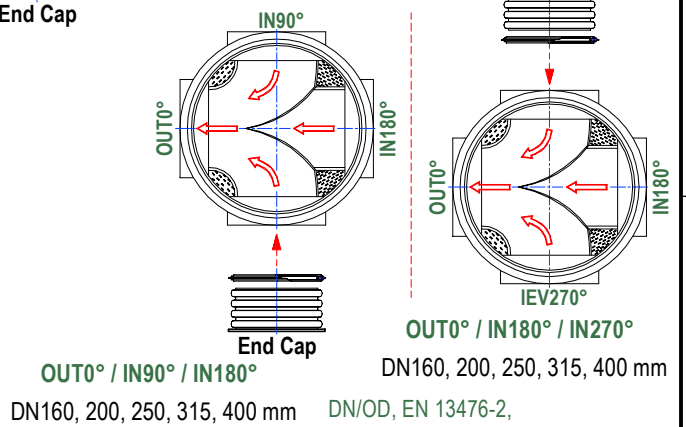

Chamber base connection type is modified according to your project to meet necessary requirements (smooth/corrugated pipe connection).

This drawing is the property of SIA Evopipes and is protected by law.



SIA "EVOPIPES"
Langervaldes str. 2a, Jelgava, LV-3002, Latvia
Company reg. No.: 50003728871
Phone: +371 63094300
E-mail: info@evopipes.lv
Website: www.evopipes.lv

FILE NAME:
DN800.630.3BL.1B.ST

SHEET: 1 OF 4

SHEET FORMAT: @ A4

SCALE:
WITHOUT SCALE
STAGE:
STANDARD DRAWING

DRAWING No.:	VERSION	REVISION	REVISION STATUS
DN800.630.3BL.1B.ST	EN	1	ACTUAL

DN800.630.2BL

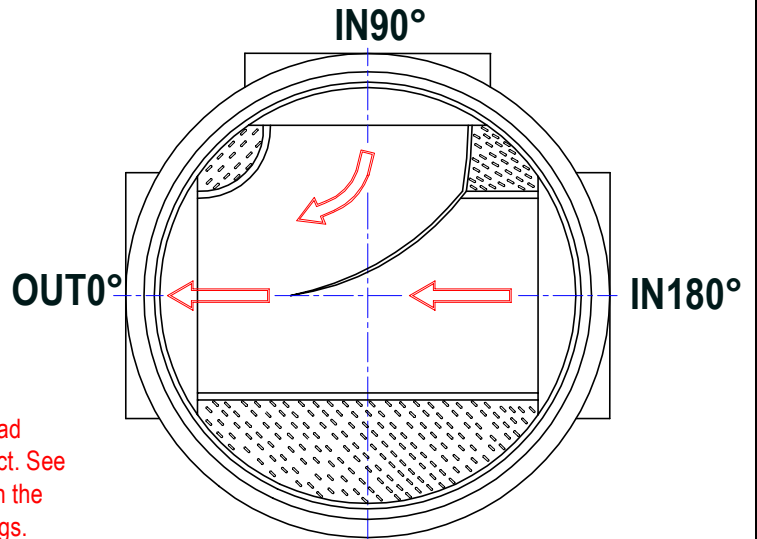

The chamber cover type (self-leveling or stationary) and load class must be selected according to the needs of the project. See www.evopipes.com for possible chamber cover solutions in the Products section - Chamber covers, grates and support rings.

OUT0° / IN90° / IN180°
DN110, 160, 200, 250, 315, 400 mm

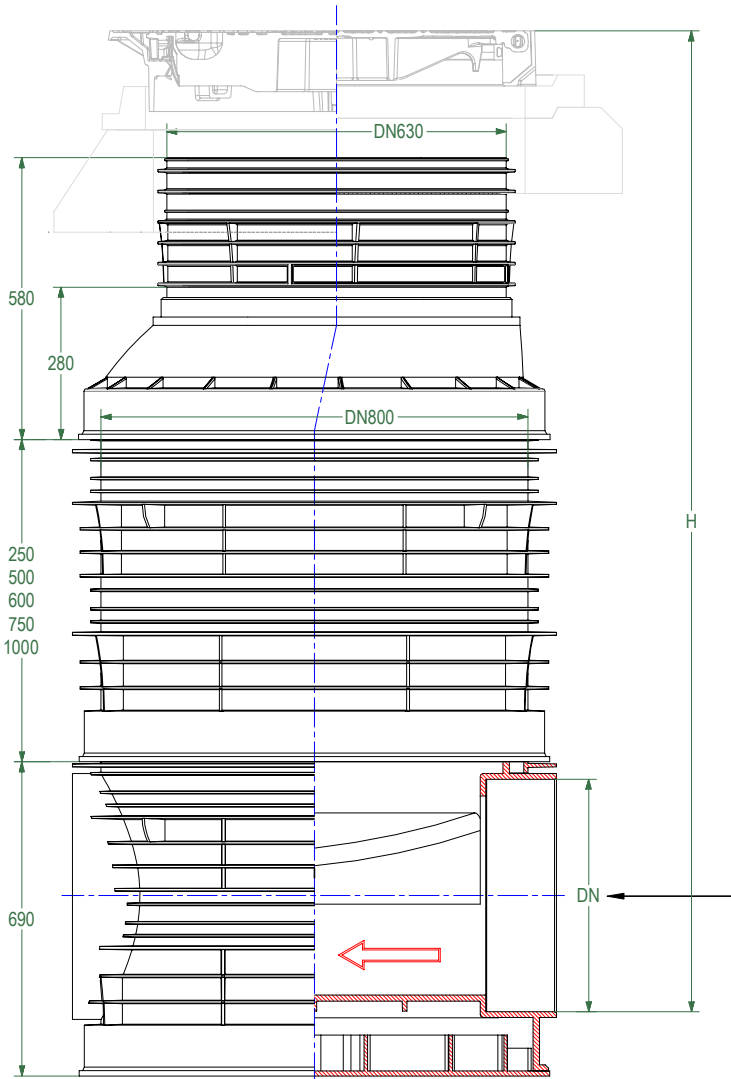

DN/OD, EN 13476-2, EN 1852-1, EN 14758-1

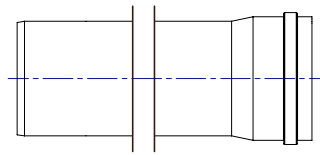

DN/OD, EN 13476-3

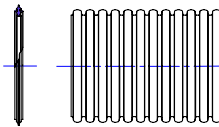

DN/ID, EN 13476-3

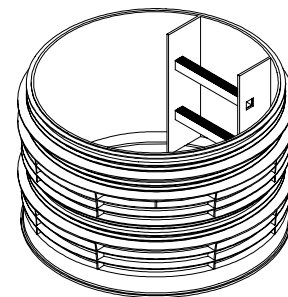
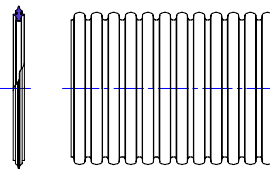

Chamber base connection type is modified according to your project to meet necessary requirements (smooth/corrugated pipe connection).

This drawing is the property of SIA Evopipes and is protected by law.



SIA "EVOPIPES"
Langervaldes str. 2a, Jelgava, LV-3002, Latvia
Company reg. No.: 50003728871
Phone: +371 63094300
E-mail: info@evopipes.lv
Website: www.evopipes.lv

FILE NAME:
DN800.630.3BL.1B.ST

SHEET: 2 OF 4

SHEET FORMAT: @ A4

SCALE:
WITHOUT SCALE

STAGE:
STANDARD DRAWING

DRAWING No.:	VERSION	REVISION	REVISION STATUS
DN800.630.3BL.1B.ST	EN	1	ACTUAL

DN800 BASE, TYPE 1B

DN800.630.1B

The chamber cover type (self-leveling or stationary) and load class must be selected according to the needs of the project. See www.evopipes.com for possible chamber cover solutions in the Products section - Chamber covers, grates and support rings.

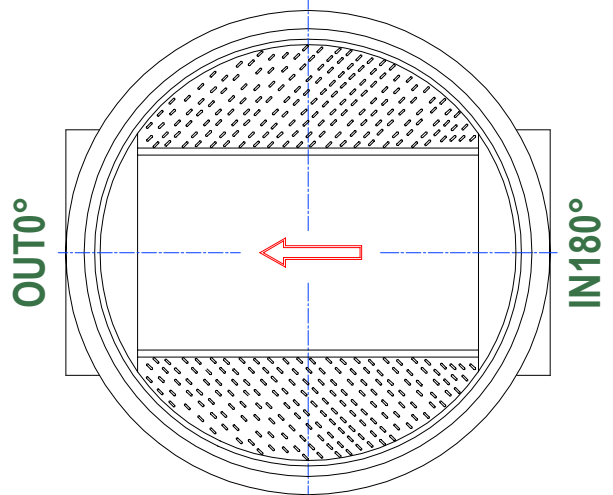

OUT0° / IN180°

DN160, 200, 250, 315, 400, (DN/ID500) mm

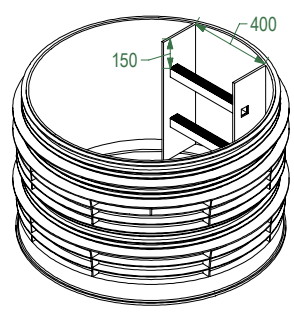
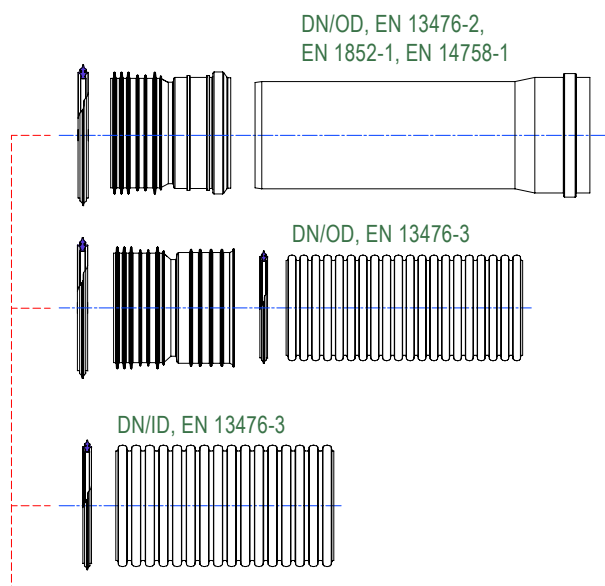
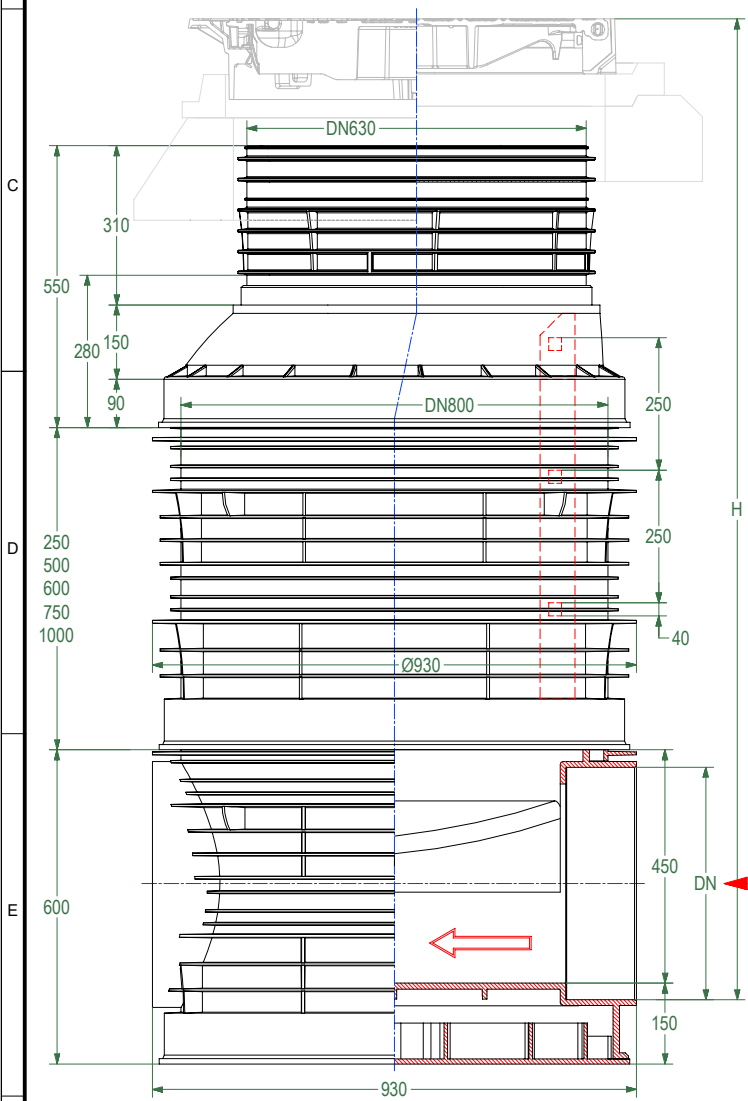

Chamber base connection type is modified according to your project to meet necessary requirements (smooth/corrugated pipe connection).

This drawing is the property of SIA Evopipes and is protected by law.



SIA "EVOPIPES"
 Langervaldes str. 2a, Jelgava, LV-3002, Latvia
 Company reg. No.: 50003728871
 Phone: +371 63094300
 E-mail: info@evopipes.lv
 Website: www.evopipes.lv

FILE NAME:
 DN800.630.3BL.1B.ST

SHEET: 3 OF 4

SHEET FORMAT: @ A4

SCALE:
 WITHOUT SCALE

STAGE:
 STANDARD DRAWING

DRAWING No.:	VERSION	REVISION	REVISION STATUS
DN800.630.3BL.1B.ST	EN	1	ACTUAL

DN800.630.ST

The chamber cover type (self-leveling or stationary) and load class must be selected according to the needs of the project. See www.evopipes.com for possible chamber cover solutions in the Products section - Chamber covers, grates and support rings.

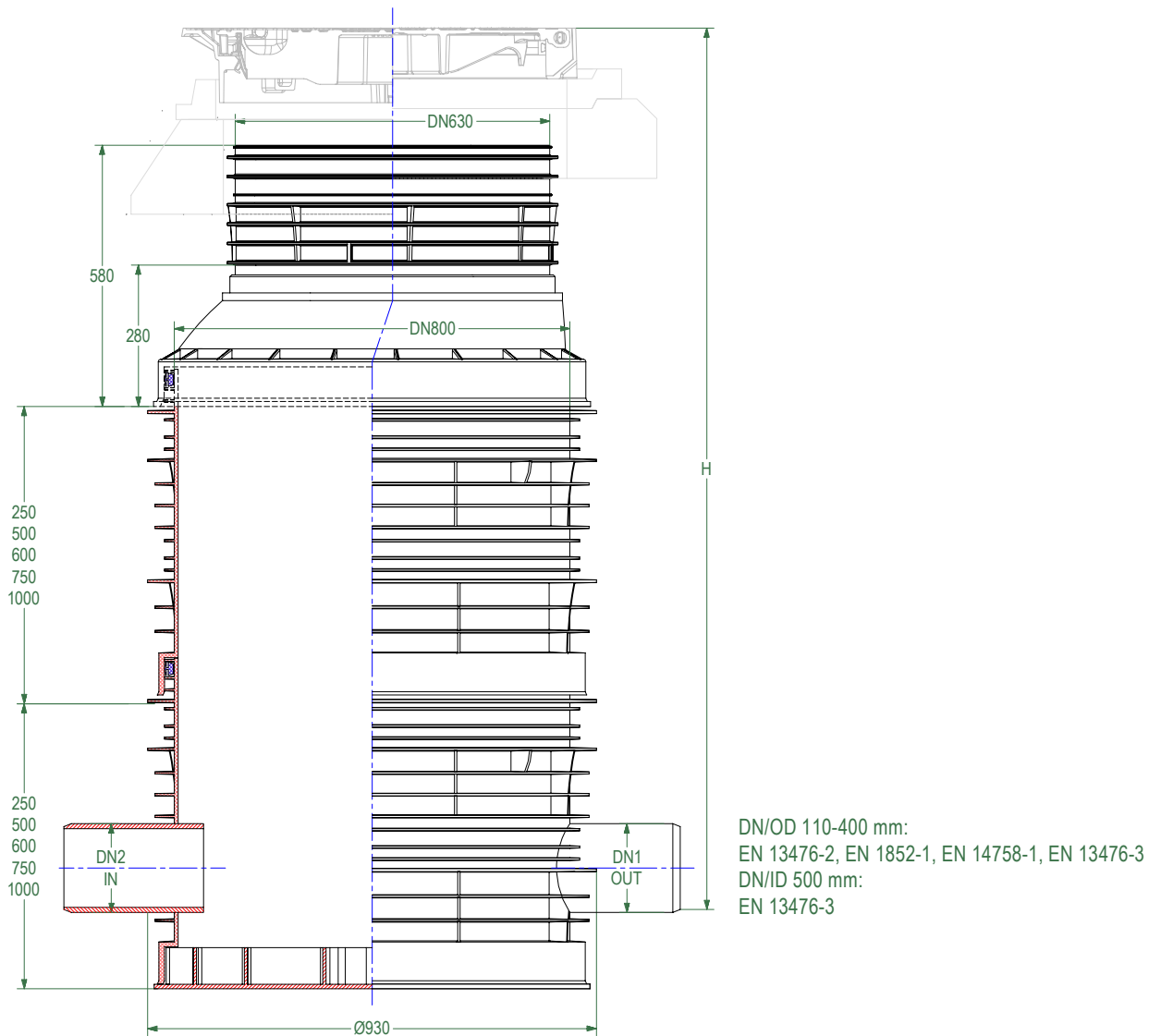

This drawing is the property of SIA Evopipes and is protected by law.



SIA "EVOPIPES"
Langervaldes str. 2a, Jelgava, LV-3002, Latvia
Company reg. No.: 50003728871
Phone: +371 63094300
E-mail: info@evopipes.lv
Website: www.evopipes.lv

FILE NAME:
DN800.630.3BL.1B.ST

SHEET: 4 OF 4

SHEET FORMAT: @ A4

SCALE:
WITHOUT SCALE

STAGE:
STANDARD DRAWING