

# DN1000.625.S.3BL

DRAWING No.:	VERSION	REVISION	REVISION STATUS
DN1000.625.S.3BL	EN	1	ACTUAL

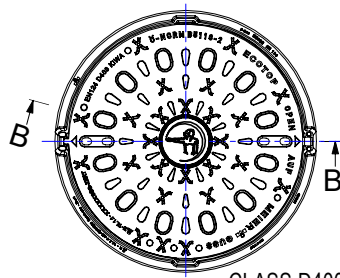

CLASS D400, EN 124-2, RAL-GZ692

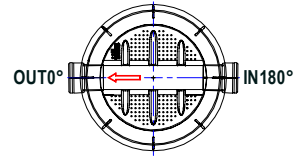
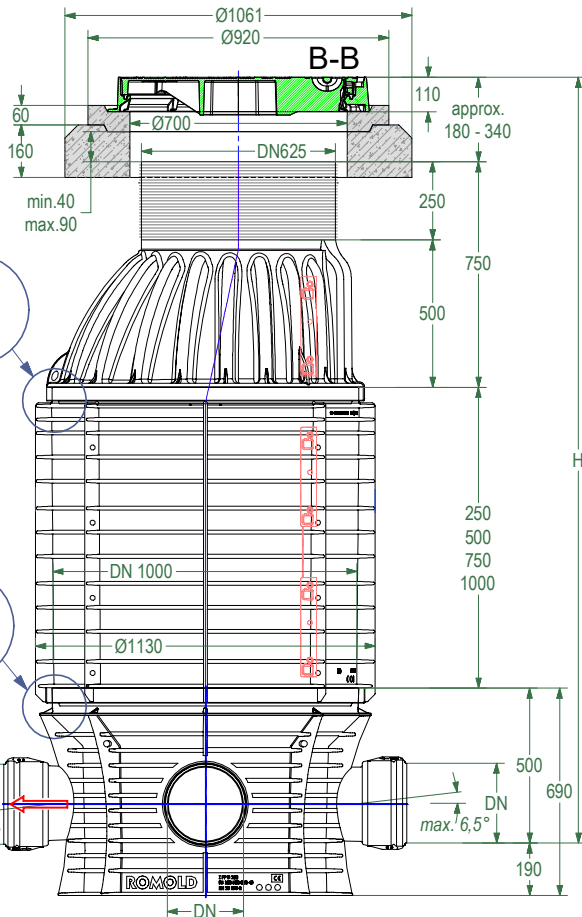

**OUT0° / IN180°**

DN160, 200, 250, 315, 400 mm

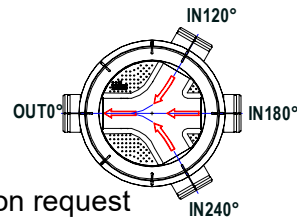

DN160 mm on request

**OUT0° / IN120° / IN180° / IN240°**

DN200, 250, 315 mm

RIGHT | LEFT

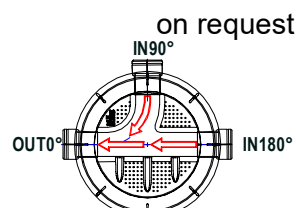

on request

**OUT0° / IN90° / IN180°**  
DN160, 200, 250, 315 mm

**OUT0° / IN180° / IN270°**  
DN160, 200, 250, 315 mm

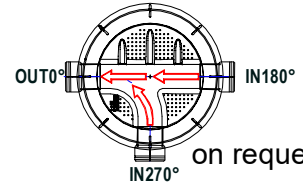

on request

PP DN/OD, EN 13476-2,  
EN 1852-1, EN 14758-1

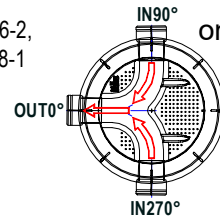

on request

**OUT0° / IN90° / IN270°**  
DN200, 250, 315 mm

RIGHT | LEFT

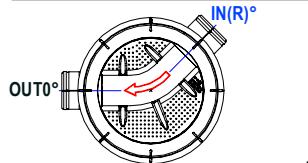

on request

**OUT0° / IN(R)°**

DN160, 200, 250, 315, 400 mm

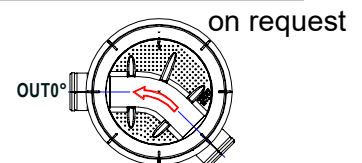

on request

**OUT0° / IN(L)°**

DN160, 200, 250, 315, 400 mm

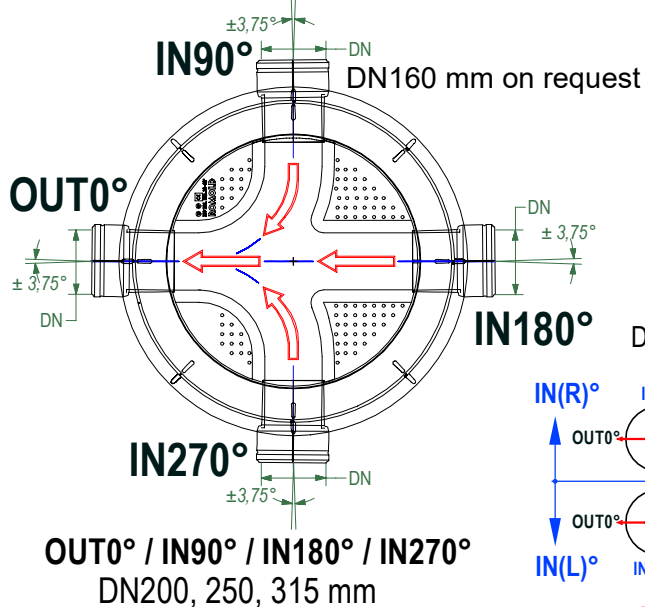

**OUT0° / IN90° / IN180° / IN270°**  
DN200, 250, 315 mm

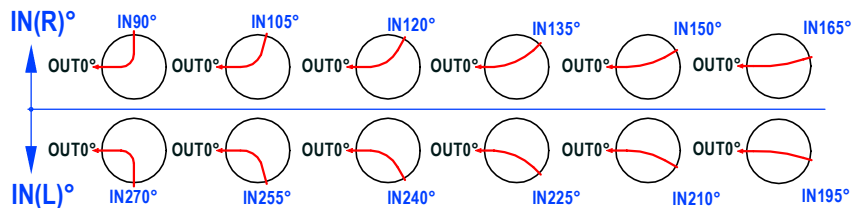

*This drawing is not suitable for the design and construction of other objects without the consent of SIA "EVOPIPES"*



SIA "EVOPIPES"  
Langervaldes str. 2a, Jelgava, LV-3002, Latvia  
Company reg. No.: 50003728871  
Phone: +371 63094300  
E-mail: [info@evopipes.lv](mailto:info@evopipes.lv)  
Website: [www.evopipes.lv](http://www.evopipes.lv)

FILE NAME:  
DN1000.625.S.3BL

SHEET: 1 OF 1

SHEET FORMAT: @ A4

SCALE:  
WITHOUT SCALE

STAGE:  
STANDARD DRAWING

# DN1000.625.S.1B

DRAWING No.:	VERSION	REVISION	REVISION STATUS
DN1000.625.S.1B	EN	1	ACTUAL

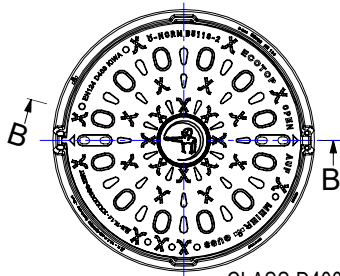

CLASS D400, EN 124-2, RAL-GZ692

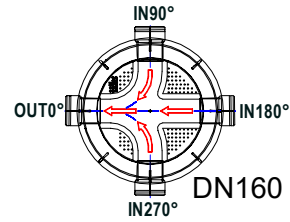
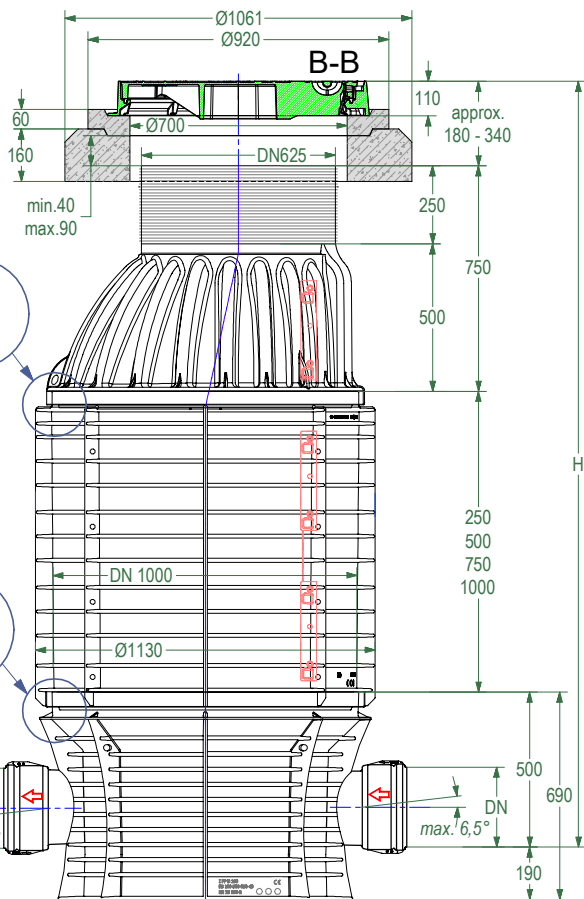

DN160 mm on request

OUT0° / IN90° / IN180° / IN270°  
DN200, 250, 315 mm

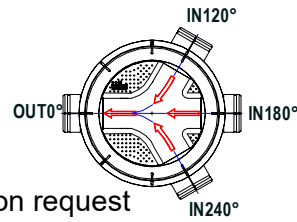

DN160 mm on request

OUT0° / IN120° / IN180° / IN240°  
DN200, 250, 315 mm

RIGHT | LEFT

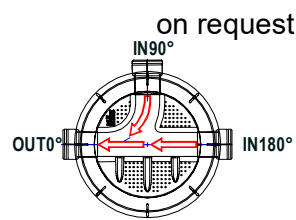

OUT0° / IN90° / IN180°  
DN160, 200, 250, 315 mm

OUT0° / IN180° / IN270°  
DN160, 200, 250, 315 mm

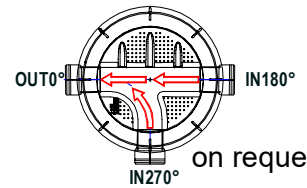

PP DN/OD, EN 13476-2,  
EN 1852-1, EN 14758-1

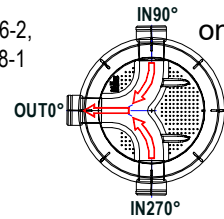

OUT0° / IN90° / IN270°  
DN200, 250, 315 mm

RIGHT | LEFT

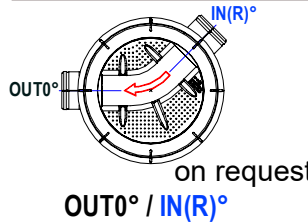

DN160, 200, 250, 315, 400 mm

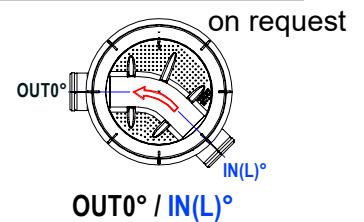

DN160, 200, 250, 315, 400 mm

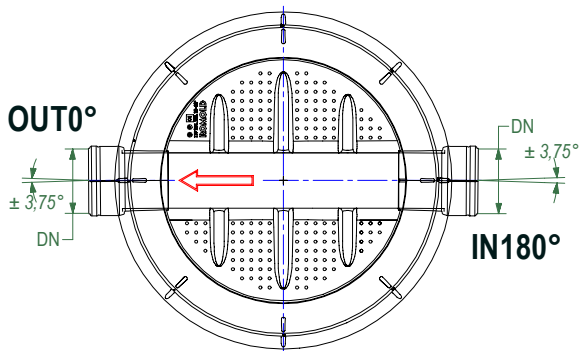

OUT0° / IN180°

DN160, 200, 250, 315, 400 mm

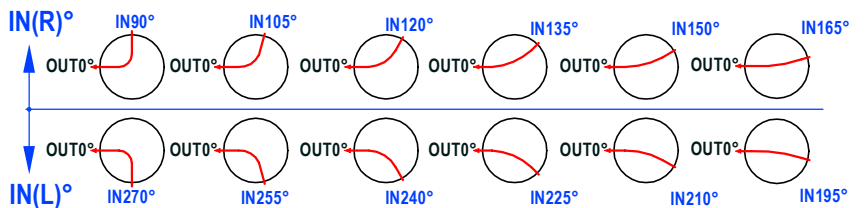

*This drawing is not suitable for the design and construction of other objects without the consent of SIA "EVOPIPES"*



SIA "EVOPIPES"  
Langervaldes str. 2a, Jelgava, LV-3002, Latvia  
Company reg. No.: 50003728871  
Phone: +371 63094300  
E-mail: [info@evopipes.lv](mailto:info@evopipes.lv)  
Website: [www.evopipes.lv](http://www.evopipes.lv)

FILE NAME:  
DN1000.625.S.1B

SHEET: 1 OF 1

SHEET FORMAT: @ A4

SCALE:  
WITHOUT SCALE

STAGE:  
STANDARD DRAWING

# DN1000.625.S.3BL.PR

DRAWING No.:	VERSION	REVISION	REVISION STATUS
DN1000.625.S.700.PR	EN	1	ACTUAL

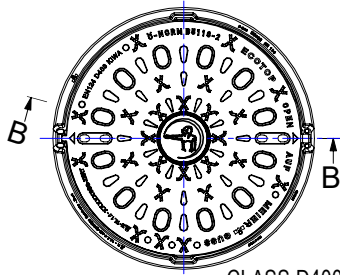

CLASS D400, EN 124-2, RAL-GZ692

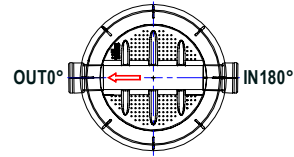
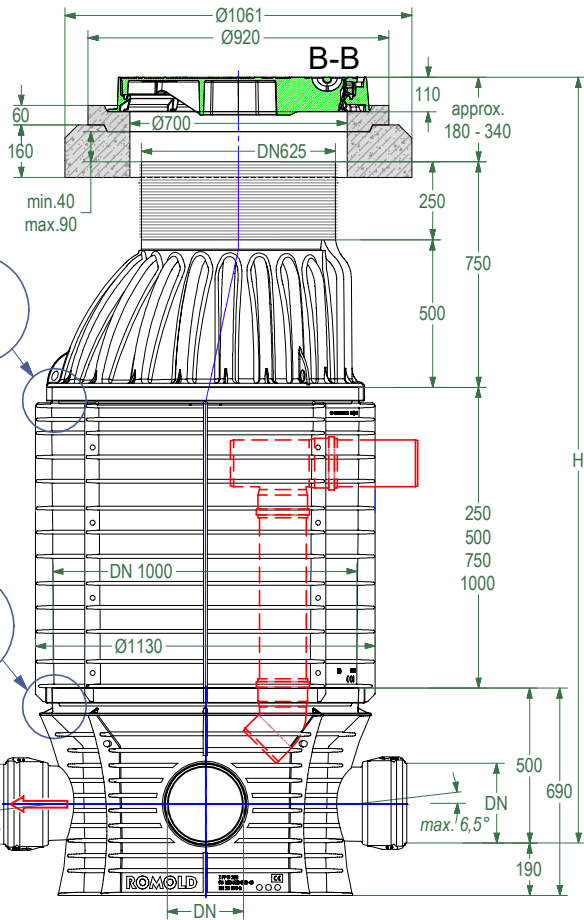

**OUT0° / IN180°**

DN160, 200, 250, 315, 400 mm

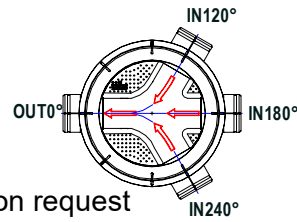

DN160 mm on request

**OUT0° / IN120° / IN180° / IN240°**

DN200, 250, 315 mm

RIGHT | LEFT

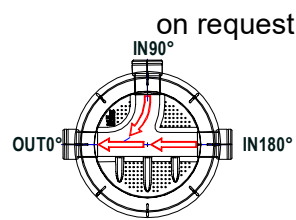

**OUT0° / IN90° / IN180°**  
DN160, 200, 250, 315 mm

**OUT0° / IN180° / IN270°**  
DN160, 200, 250, 315 mm

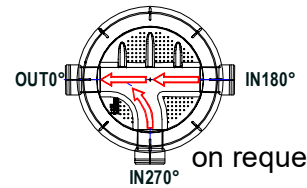

on request

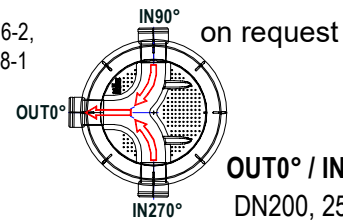

**OUT0° / IN90° / IN270°**  
DN200, 250, 315 mm

RIGHT | LEFT

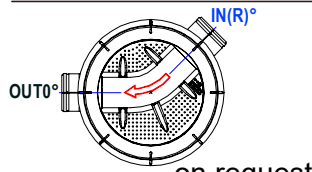

**OUT0° / IN(R)°**  
DN160, 200, 250, 315, 400 mm

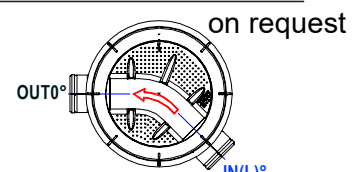

**OUT0° / IN(L)°**  
DN160, 200, 250, 315, 400 mm

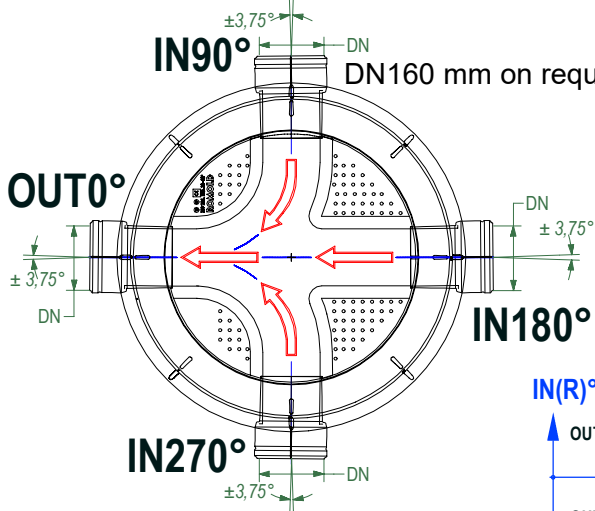

**OUT0° / IN90° / IN180° / IN270°**  
DN200, 250, 315 mm

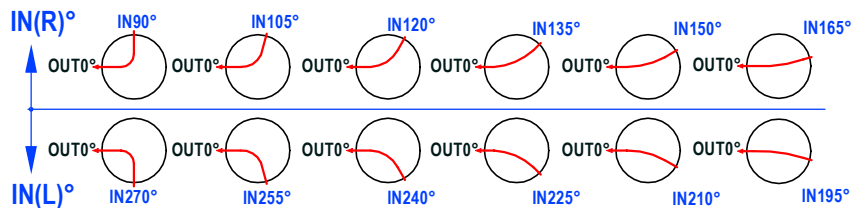

*This drawing is not suitable for the design and construction of other objects without the consent of SIA "EVOPIPES"*



SIA "EVOPIPES"  
Langervaldes str. 2a, Jelgava, LV-3002, Latvia  
Company reg. No.: 50003728871  
Phone: +371 63094300  
E-mail: [info@evopipes.lv](mailto:info@evopipes.lv)  
Website: [www.evopipes.lv](http://www.evopipes.lv)

FILE NAME:  
DN1000.625.S.700.PR

SHEET: 1 OF 1

SHEET FORMAT: @ A4

SCALE:  
WITHOUT SCALE

STAGE:  
STANDARD DRAWING

# DN1000.625.S.1B.PR

DRAWING No.:	VERSION	REVISION	REVISION STATUS
DN1000.625.S.700.PR	EN	1	ACTUAL

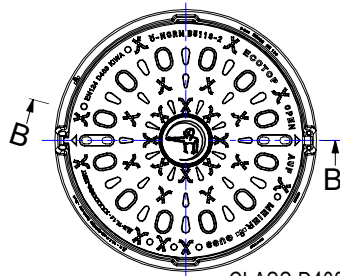

CLASS D400, EN 124-2, RAL-GZ692

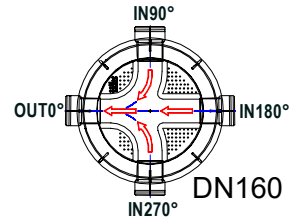
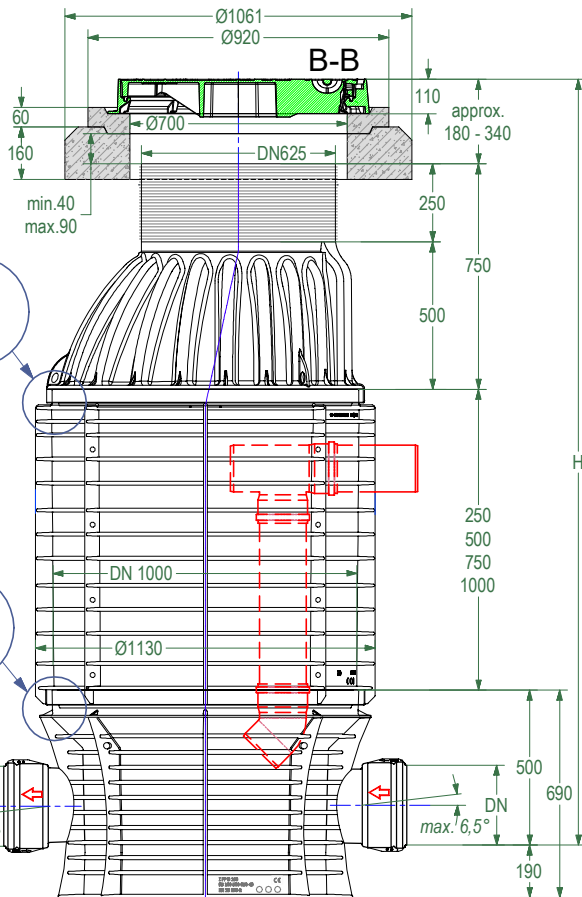

DN160 mm on request

OUT0° / IN90° / IN180° / IN270°  
DN200, 250, 315 mm

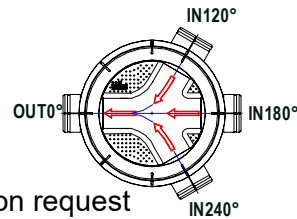

DN160 mm on request

OUT0° / IN120° / IN180° / IN240°  
DN200, 250, 315 mm

RIGHT | LEFT

on request

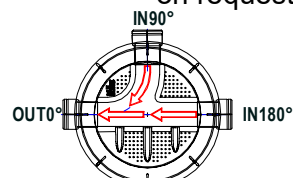

OUT0° / IN90° / IN180°  
DN160, 200, 250, 315 mm

OUT0° / IN180° / IN270°  
DN160, 200, 250, 315 mm

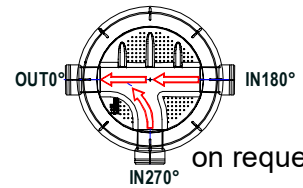

on request

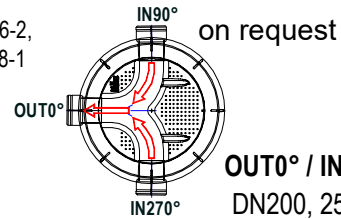

OUT0° / IN90° / IN270°  
DN200, 250, 315 mm

RIGHT | LEFT

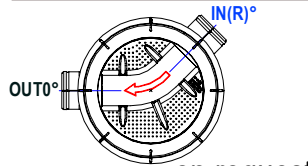

on request  
OUT0° / IN(R)°

DN160, 200, 250, 315, 400 mm

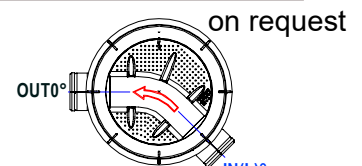

on request  
OUT0° / IN(L)°

DN160, 200, 250, 315, 400 mm

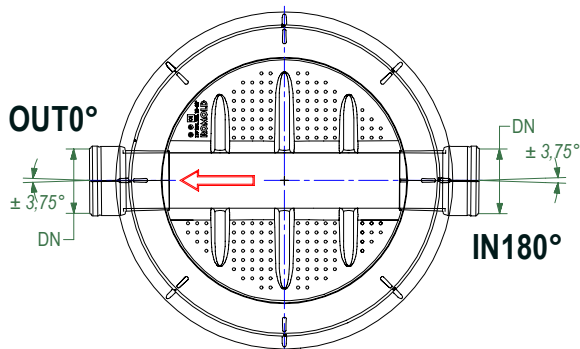

OUT0° / IN180°

DN160, 200, 250, 315, 400 mm

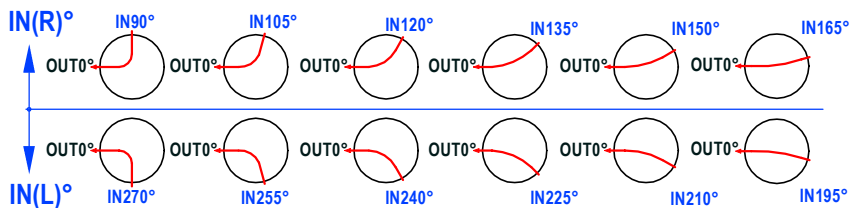

This drawing is not suitable for the design and construction of other objects without the consent of SIA "EVOPIPES"



SIA "EVOPIPES"  
Langervaldes str. 2a, Jelgava, LV-3002, Latvia  
Company reg. No.: 50003728871  
Phone: +371 63094300  
E-mail: [info@evopipes.lv](mailto:info@evopipes.lv)  
Website: [www.evopipes.lv](http://www.evopipes.lv)

FILE NAME:  
DN1000.625.S.700.PR

SHEET: 1 OF 1

SHEET FORMAT: @ A4

SCALE:  
WITHOUT SCALE

STAGE:  
STANDARD DRAWING