



# Cable protection systems INSTALLATION GUIDELINES

# Content

<b>WARNING TAPE INSTALLATION</b>	<b>3</b>	<b>THE INSTALLED OF CABLE POWER LINES IN THE CABLE BLOCKS TO BE CONCRETED</b>	<b>22</b>
Warning tape installation example		An example of the installed of cable power lines in a cable block	23
<b>PROTECTION PROFILE INSTALLATION</b>	<b>4</b>	<b>EVOCAB SPACER</b>	<b>24</b>
Protection profile installation example		Connecting EVOCAB spacers to one another	27
<b>SELECTION OF THE COMPRESSION STRENGTH CLASS OF THE PROTECTION PIPE DEPENDING ON THE PLACE OF INSTALLATION</b>	<b>5</b>	Example of connecting EVOCAB spacers to each other creating a cable block in 2 height levels using EVOCAB spacers 8-protection pipes + 4-protection pipes = 12-protection pipes	28
Recommended use of protection pipes according to their compression strength class according to load class areas - according to the classification specified in EN 124-1		Example of assembly of EVOCAB spacers in a cable block of 12 protection pipes in 3 height levels	
<b>INSTALLATION OF A PROTECTION PIPE ABOVE GROUND UNDER THE DIRECT INFLUENCE OF SUNLIGHT</b>	<b>6</b>	Example of the installation of a 90° turn of a cable block route with EVOCAB FLEX N 450 protection pipes and EVOCAB spacers	29
<b>RECOMMENDATIONS FOR THE CONSTRUCTION OF CABLE POWER LINE TURNS</b>	<b>8</b>	Example of the installation of a 90° turn of a cable block route with EVOCAB HARD N 450 protection pipes, EVOCAB ELBOWS N 750 and EVOCAB spacers	30
<b>SELECTION OF THE INNER DIAMETER OF THE PROTECTION PIPE DEPENDING ON THE SIZE OF THE CABLE</b>	<b>9</b>	Example of the installation of a 90° and 45° turn of a cable block route with EVOCAB HARD N 750 protection pipes, EVOCAB ELBOWS N 750 and EVOCAB spacers	31
Determinatio of the inner diameter of the protection pipe		<b>INSTALLATION OF CABLE BLOCKS</b>	<b>33</b>
<b>INSTALLATION OF CABLE POWER LINES AT ENTRANCES TO RESIDENTIAL AND PUBLIC BUILDINGS</b>	<b>11</b>	Installation example of the cable block: in one layer with 4 protection pipes	
Example of installation of cable entry through the foundations of the building		Installation example of the cable block: in two layers with 8 protection pipes	34
Example of installation of cable entry through the foundations of the building at the basement	12	Installation example of the cable block: in three layers with 12 protection pipes	35
<b>GUIDELINES FOR THE INSTALLATION OF CABLE PROTECTION PIPE</b>	<b>13</b>	An example of an illustration of the installation of a cable block in the green area at a depth of 1,0 m from the ground surface	36
Installation of a horizontally straight or gently curved protection pipeline route in a trench		<b>INSTALLATION OF CABLE BLOCKS CLOSE TO THE GROUND SURFACE IN HIGH TRAFFIC LOAD AREA / CONDITIONS</b>	<b>41</b>
Cross section of the protection pipe trench (according to EN 1610 standard 3, Figure 1)		The installation of the cable block in concrete with the minimum thickness of the covering layer in the driving part of the road	
The protection pipe fastening bedding construction type 1 in the trench, compiled in accordance with EN 1610 standard 7.2.1. point Figure 3	14	The installation of the cable block in concrete below the minimum allowable cover layer thickness in the driving part of the road	42
Minimum trench width	15	<b>TRANSPORTATION AND STORAGE OF PROTECTION PIPES AND THEIR ACCESSORIES</b>	<b>43</b>
Installation at low temperatures	16		
Joint of protection pipes			
Trench bedding			
Backfilling of the trench	18		
Special protective measures	19		
Compaction of filling			
Recommended compaction methods	20		
Main backfill	21		
Compaction quality control			
Soil density after installation			



## WARNING TAPE INSTALLATION

Warning tapes above power supply networks and electronic communication network cables or cable protection pipes are built from 0,2 to 0,4 m above the cable or protection pipe. The construction height above the cable (or pipe) might be different considering the national requirements or construction standards, or the requirements of the network manager (operator).



### Warning tape installation example

#### LEGEND:

- 1 Warning tape;
- 2 Trench filling material in the zone around the protection pipe, e.g. sand or fine gravel;
- 3 Protection pipe.

The minimum thickness of lower bedding filling layer **a**:

- ▶ 100 mm in usual soil conditions;
- ▶ 150 mm in rock or hard soil conditions.

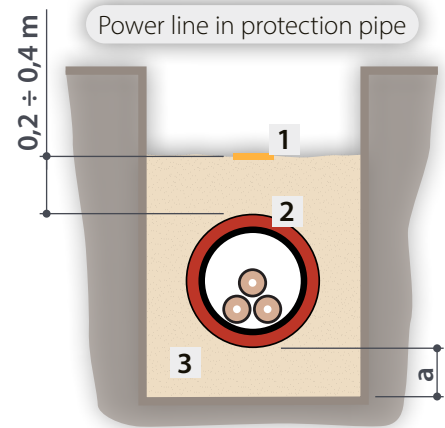

#### LEGEND:

- 1 Warning tape;
- 2 Trench filling material in the zone around the protection pipe, e.g. sand or fine gravel;
- 3 Protection pipe with the filled up cable channel;
- 3R Protection pipe with recommended spare cable channel;
- 4 EVOCAB spacer.

The minimum thickness of lower bedding filling layer **a**:

- ▶ 100 mm in usual soil conditions;
- ▶ 150 mm in rock or hard soil conditions.

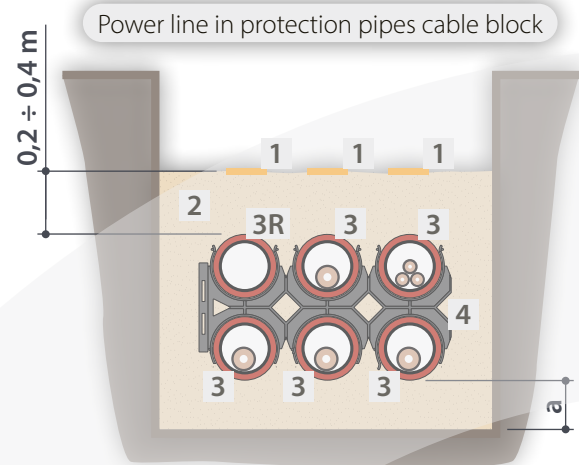



## PROTECTION PROFILE INSTALLATION

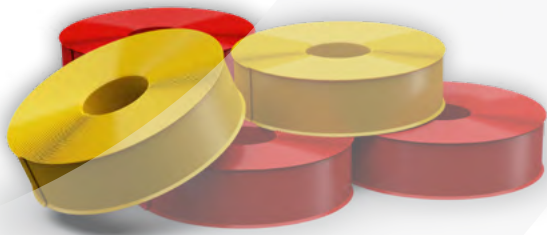

The protection profile is intended to ensure the protection of underground cables or cable protection pipes against mechanical damage and to visibly indicate the location of underground cables or cable protection pipes along their length and width.

When installing a cable protection profile above the cable or cable protection pipe, a warning tape must be installed as well.

The protection profile must be installed from 0,1 m to 0,2 m above the cable or cable protection pipe, in accordance with the requirements of the EN 50520 standard, while the warning tape must be installed above the protection profile at a height of 0,1 m to 0,2 m.

### Protection profile installation example

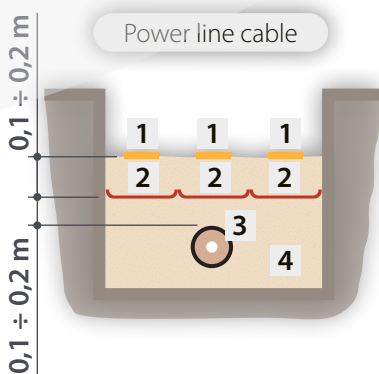

#### LEGEND:

- 1 Warning tape;
- 2 Protection profile;
- 3 Cable;
- 4 Trench filling material in the zone around the protection pipe, e.g. sand or fine gravel.

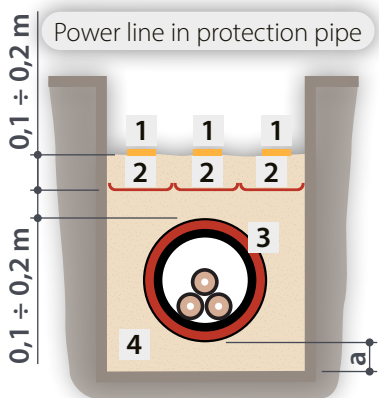

#### LEGEND:

- 1 Warning tape;
- 2 Protection profile;
- 3 Protection pipe;
- 4 Trench filling material in the zone around the protection pipe, e.g. sand or fine gravel.

The minimum thickness of lower bedding filling layer **a**:

- ▶ 100 mm in usual soil conditions;
- ▶ 150 mm in rock or hard soil conditions.

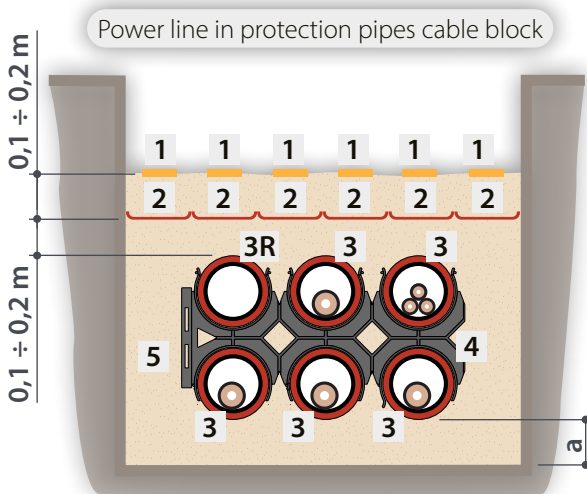

#### LEGEND:

- 1 Warning tape;
- 2 Protection profile;
- 3 Protection pipe with the filled up cable channel;
- 3R Protection pipe with recommended spare cable channel;
- 4 EVOCAB spacer;
- 5 Trench filling material in the zone around the protection pipe, e.g. sand or fine gravel.

The minimum thickness of lower bedding filling layer **a**:

- ▶ 100 mm in usual soil conditions;
- ▶ 150 mm in rock or hard soil conditions.



# SELECTION OF THE COMPRESSION STRENGTH CLASS OF THE PROTECTION PIPE DEPENDING ON THE PLACE OF INSTALLATION

Recommended use of protection pipes according to their compression strength class according to load class areas - according to the classification specified in EN 124-1

- A15** Areas which can only be used by pedestrians and pedal cyclists;
- B125** Pedestrian areas and comparable areas, car parks or car parking decks;
- C250** For construction in road curb areas, as well as on the sides of road carriageways and their slope areas outside the range of exposure to external traffic load and in its border zone.
- D400** Carriageways of roads (including pedestrian streets), hard shoulders and parking areas, for all types of road vehicles;
- E600** Areas imposing high wheel loads, e.g. ports, docks, aircraft pavements;
- F900** Areas imposing particularly high wheel loads, e.g. aircraft pavements.

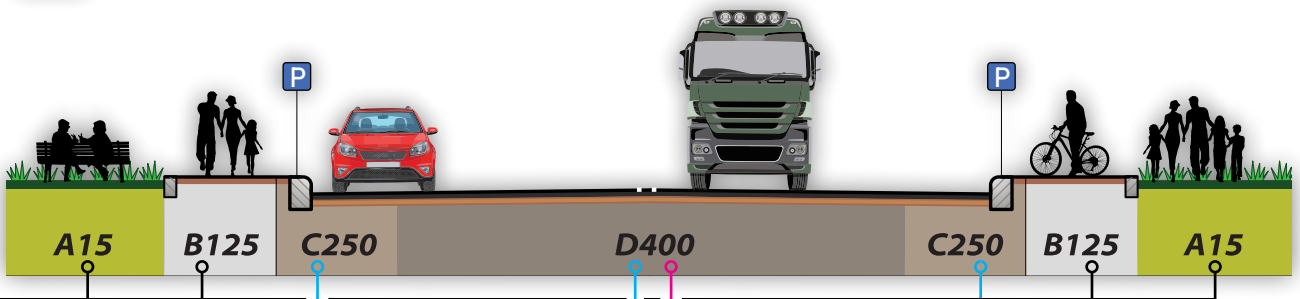

**EVOCAB FLEX N 450**

**A15**  
**B125**

EN 61386-24  
DN/OD : 40, 50, 63, 75, 90, 110, 125, 160

**EVOCAB HARD N 450**

**A15**  
**B125**

EN 61386-24  
DN/OD : 50, 63, 75, 90, 110, 125, 160

**EVOCAB HARD N 750**

**C250**  
**D400**

EN 61386-24  
DN/OD : 50, 63, 75, 90, 110, 125, 160

**A15** **B125**

**RIGID MULTI PP N 750**

**C250**  
**D400**

EN 61386-24  
DN/OD : 110, 160

**A15** **B125**

**EVOCAB SUPERHARD N 1250**

**D400**  
**E600**  
**F900**

EN 61386-24  
DN/OD : 110, 160, 200, 250, 315, 400

**A15** **B125** **C250**

**EVOCAB STING N 1250**

**D400**  
**E600**  
**F900**

EN 61386-24  
DN/OD : 50, 63, 75, 90, 110, 125, 160, 200, 225, 250, 315, 400, 500

**A15** **B125** **C250**

- 1** Designed for installation in the C250 and D400 class area, but can be installed in the A15 and B125 class area as well;
- 2** Designed for installation in the D400 class area, as well as in the high intensity traffic area, e.g. in the E600 and F900 class area, but can also be installation in the A15, B125 and C250 class area.



Non-observance of protection pipe installation technology processes, e.g. compaction of the trench filling material in the compaction area around the protection pipe, as well as incorrect selection of the compression strength class of the protection pipe in the intended installation place, e.g. in the area under the driving part with the intense (dynamic) traffic load of heavy machinery, during its operation can lead not only to excessive diameter (deviation) deformation, but also to crushing and its flattening.

The permissible deformation of the inner diameter of the protection pipe after its installation must not exceed 5%, according to the requirement of clause 10.2.5 of the standard EN 61386-24.

On the left is the bad example - wrongly choose compression strength class of the protection pipe. Intensity of traffic load hasn't been considered properly.

## INSTALLATION OF A PROTECTION PIPE ABOVE GROUND UNDER THE DIRECT INFLUENCE OF SUNLIGHT

For such purposes EVOPIPES recommends to use protection pipes designed for the protection and insulation of cables and wires under the influence of direct UV rays outside and inside buildings, such as EVOCAB FLEX FR UV 0H protection pipes.



During the installation of the cable power line, it is mandatory to observe the minimum permissible ambient temperature, in which the protection pipes and cables of the cable power line may be built, in accordance with the manufacturer's requirements.

Cable power lines must be installed in a manner that mechanical damage does not occur in the cables during construction and operation.

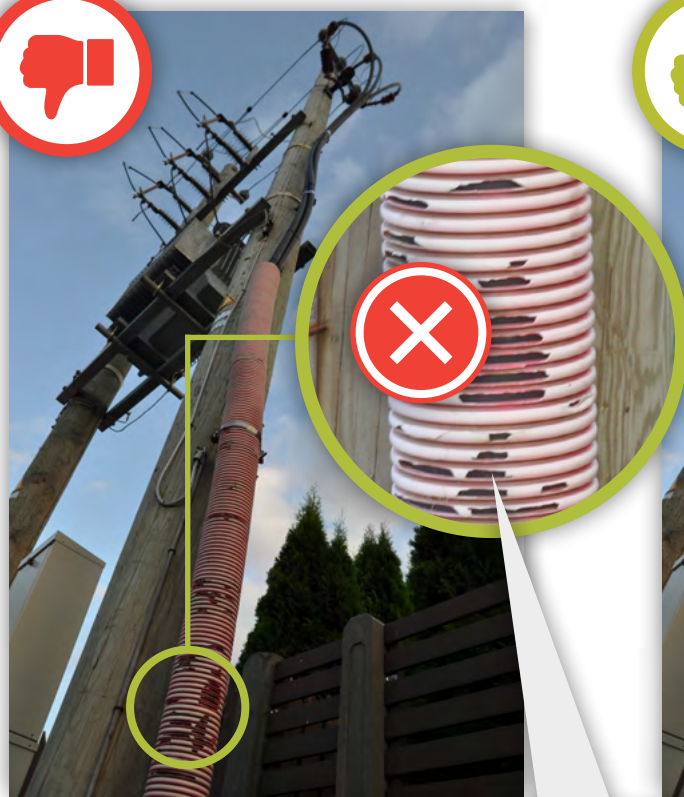

Long-term exposure of polymer products to sunlight can lead to their degradation.

As a result, polymer products lose their properties with time, e.g. such as:

- ▶ resistance to compression strength, resistance to impact, resistance to bending (flexibility and elasticity);
- ▶ visual appeal.

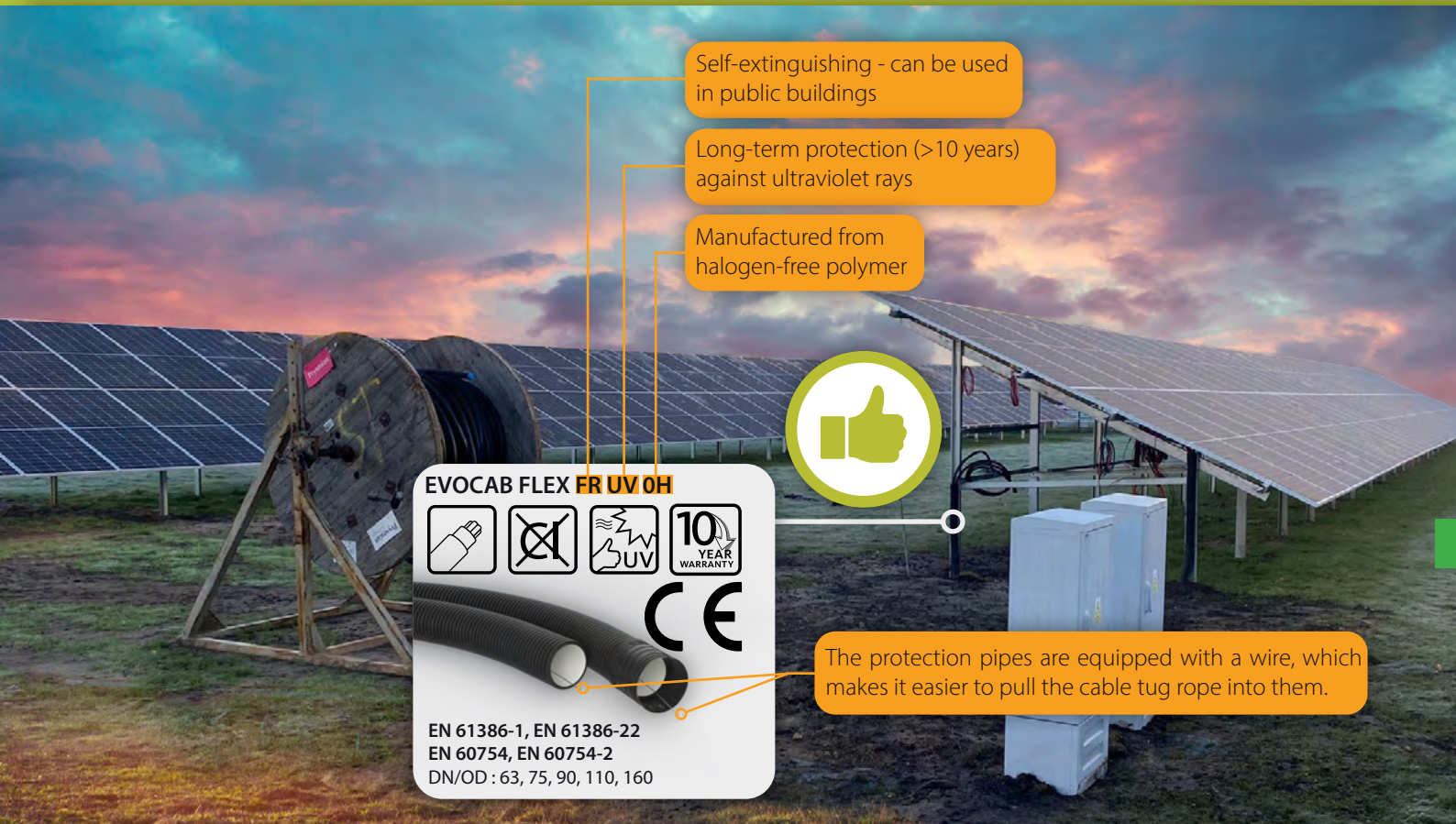

Self-extinguishing - can be used in public buildings

Long-term protection (>10 years) against ultraviolet rays

Manufactured from halogen-free polymer



### EVOcab FLEX FR UV 0H

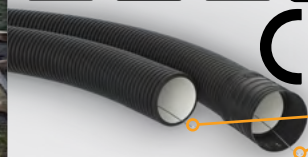

EN 61386-1, EN 61386-22  
EN 60754, EN 60754-2  
DN/OD : 63, 75, 90, 110, 160

The protection pipes are equipped with a wire, which makes it easier to pull the cable tug rope into them.

### EVOcab HARD N 450



EN61386-24  
DN/OD : 50, 63, 75, 90, 110, 125, 160

### EVOcab FLEX N 450



EN 61386-24  
DN/OD : 40, 50, 63, 75, 90, 110, 125, 160

### EVOcab HARD N 750



EN 61386-24  
DN/OD : 50, 63, 75, 90, 110, 125, 160

### APPLICATION

EVOcab FLEX FR UV 0H is intended for the protection of cables and wires from direct exposure to UV rays.

- ✓ For construction under direct UV rays;
- ✓ In solar parks;
- ✓ Transitions from underground cable lines to overhead lines;
- ✓ Inside buildings - in inter-floor cable trunks, main distribution rooms;
- ✓ Substation entry and building entry for cable protection.

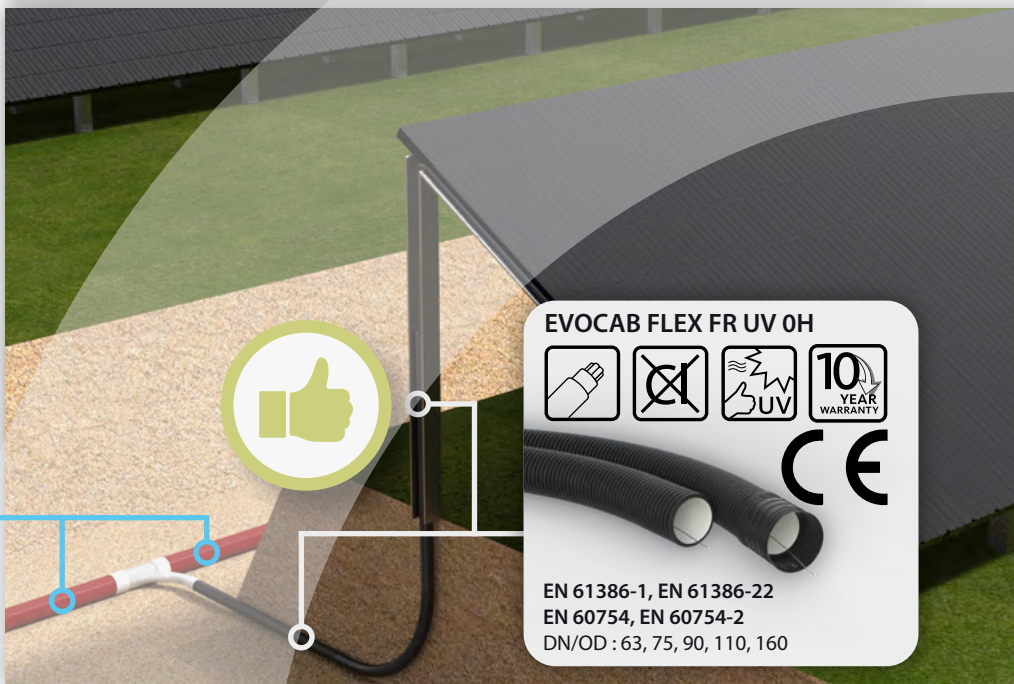

### EVOcab FLEX FR UV 0H

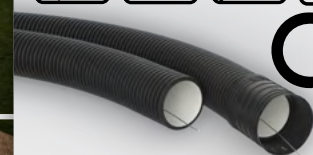

EN 61386-1, EN 61386-22  
EN 60754, EN 60754-2  
DN/OD : 63, 75, 90, 110, 160



## RECOMMENDATIONS FOR THE CONSTRUCTION OF CABLE POWER LINE TURNS

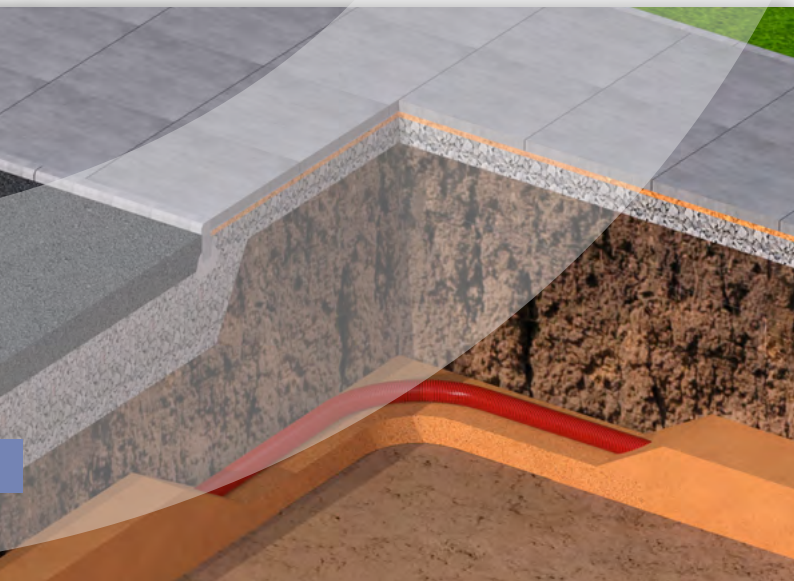

It is recommended to construct the bends of the protection pipe route flat, this will make it easier to pull the cables into the protection pipes.

During the design stage of the cable power line route or during the installation, when choosing the bending radius of the protection pipe, we recommend that you take into account the minimum bending radius of the cable recommended by the cable manufacturer.

The minimum bending radius of the protection pipe is limited by the deformation of its permissible internal diameter, which is regulated by EN 61386-24 standard (clause 10.4.3). According to clause 10.4.3, the bending radius must be such that the deformation of the inner diameter of the protection pipe does not exceed 5%. EVOPIPES recommends the following minimum bending radius for its products (see Table 1).

The minimum bending radius of the protection pipe is valid at an ambient temperature of +20 °C. At low ambient temperatures, we recommend increasing it, e.g. at +10 °C by 1,5 times and at (+5 ÷ ±0) °C by 2 times.

At ambient temperature  
**T: +10 °C**

**$R \geq 1,5 \times R_{min}$** , at T: +20 °C

At ambient temperature  
**T: (+5 ÷ ±0) °C**

**$R \geq 2,0 \times R_{min}$** , at T: +20 °C

*Note: When performing the calculation, we choose the size of the diameter of the protection pipe and the corresponding minimum value of the bending radius  $R_{min}$ , at the ambient temperature T: +20 °C.*

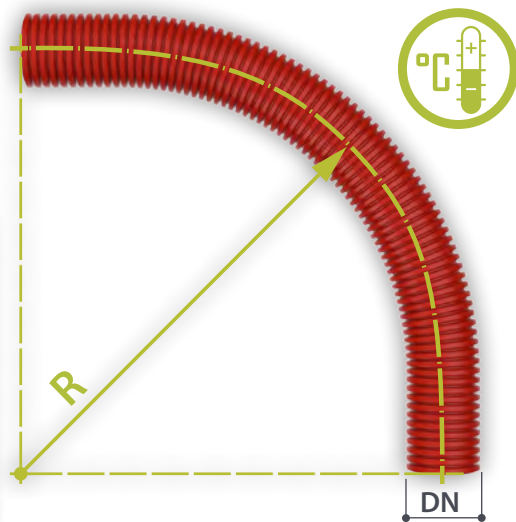

### EVOFLEX N 450



### EVOFLEX FR UV 0H

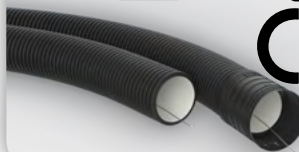

### EVOFLEX ELBOW N 750 & N 450



**450**

Table 1

PRODUCT	DN, mm								
	40	50	63	75	90	110	125	160	
EVOFLEX FR UV 0H			63	75		110		160	
EVOFLEX N 450	40	50	63	75	90	110	125	160	
EVOFLEX ELBOW N 450		50				110		160	
EVOFLEX ELBOW N 750		50				110		160	
PARAMETERS		At ambient temperature T: +20 °C							
Minimum bending radius $R_{min}$ , mm	≥230	≥230	≥230	≥230	≥230	≥230	≥280	≥280	
PARAMETERS		At ambient temperature T: +10 °C							
Minimum bending radius $R_{min}$ , mm	≥345	≥345	≥345	≥345	≥345	≥345	≥420	≥420	
PARAMETERS		At ambient temperature T: (+5 ÷ ±0) °C							
*Minimum bending radius $R_{min}$ , mm	≥460	≥460	≥460	≥460	≥460	≥460	≥560	≥560	

\* - During the design process or installation works, we recommend choosing the minimum value of the bending radius  $R_{min}$  parameter that corresponds to the ambient temperature at T: (+5 ÷ ±0) °C.





## SELECTION OF THE INNER DIAMETER OF THE PROTECTION PIPE DEPENDING ON THE SIZE OF THE CABLE

When choosing a protection pipe, it is recommended that the inner diameter of the pipe is not smaller than the two outer diameters of the cable.

EVOPIPES recommends choosing the minimum diameter of the protection pipe depending on the size of the cable and the installation conditions, as well as considering the type of cable (see table 2).

Choose the minimum permissible inner diameter size of the protection pipe, depending on: type of protection pipe, compression strength class, installation conditions, cable type and external size of the cable diameter.



### Determination of the inner diameter of the protection pipe

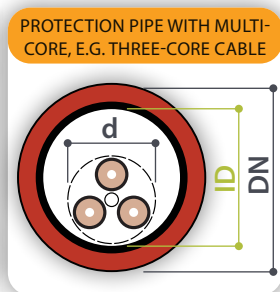
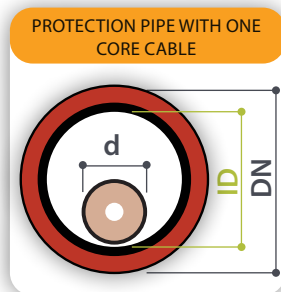

The ratio of the inner diameter of the protection pipe to the outer dimension of the cable diameter, if a single cable is used:

**EVO CAB FLEX FR UV0H | EVO CAB FLEX N 450 | EVO CAB HARD N 450  
EVO CAB HARD N750 | RIGID MULTI PP N 750 | EVO CAB SUPERHARD N 1250**

$$ID \geq 2,00 \times d$$

Where:

- DN - Protection pipe nominal outside diameter, mm;
- ID - Protection pipe inner diameter, mm;
- d - Cable outside diameter, mm.

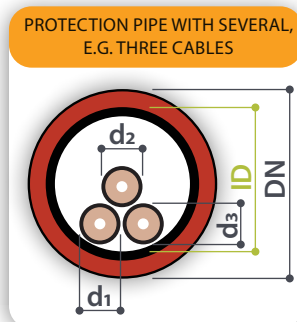

Use this formula to determine the inside diameter dimensions if multiple cables are planned to be routed into the protection pipe:

**EVO CAB FLEX FR UV0H | EVO CAB FLEX N 450 | EVO CAB HARD N 450  
EVO CAB HARD N750 | RIGID MULTI PP N 750 | EVO CAB SUPERHARD N 1250**

$$ID \geq 2,00 \times \sqrt{d_1^2 + d_2^2 + d_3^2 \dots + d_n^2}$$

Where:

- DN - Protection pipe nominal outside diameter, mm;
- ID - Protection pipe inner diameter, mm;
- dn - Cable outside diameter size and its number, mm; (n - Has a cable number index, e.g. d<sub>1</sub>, d<sub>2</sub>, d<sub>3</sub>...d<sub>n</sub>).

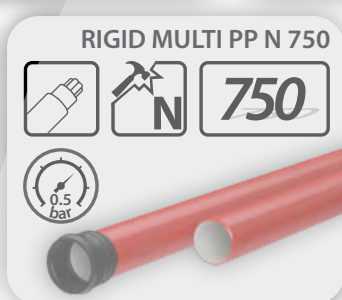



Table 2

Protection pipe with single cable: ratio of ID to d:								ID ≥ 2,00 x d				
Protection pipe with multiple cables: Ratio of ID to total dn:								ID ≥ 2,00 x $\sqrt{d_1^2 + d_2^2 + d_3^2 \dots + d_n^2}$				
EVOCAB FLEX FR UV OH												
DN, mm			63	75	90	110		160				
ID, mm			50,9	61,9	75,2	92,9		136,7				
EVOCAB FLEX N 450												
DN, mm	40	50	63	75	90	110	125	160				
ID, mm	31,1	39,8	50,9	62,1	75,4	93,1	105,9	136,9				
EVOCAB HARD N 450												
DN, mm		50	63	75	90	110	125	160				
ID, mm		40,7	51,7	62,7	76,2	94,1	106,7	137,0				
EVOCAB HARD N 750												
DN, mm		50	63	75	90	110	125	160				
ID, mm		40,7	51,7	62,7	76,2	94,1	106,7	137,0				
RIGID MULTI PP N 750												
DN, mm						110		160				
ID, mm						101,2		147,6				
EVOCAB SUPERHARD N 1250												
DN, mm						110		160	200	250	315	400
ID, mm						93,8		138,9	174,6	215,9	274,1	349,8

**Where:**

- DN - protection pipe nominal outside diameter, mm;
- ID - protection pipe inner diameter, mm;
- d - cable outside diameter, mm;
- dn - cable outside diameter size and its number, mm;
- (n - cable number index, e.g. d<sub>1</sub>, d<sub>2</sub>, d<sub>3</sub>...dn).





## INSTALLATION OF CABLE POWER LINES AT ENTRANCES TO RESIDENTIAL AND PUBLIC BUILDINGS

When installing the entrances of cable power lines, the necessary airtightness, mechanical protection and fire safety requirements must be ensured in the buildings.

When installing the cable power line along the building facade, the cables must be protected with UV-resistant protection pipes, e.g. EVOCAB FLEX FR UV 0H type protection pipes.

In cases where the inlet is built through the foundation of the building, protection against the infiltration of groundwater must be provided.

Example of installation of cable entry through the foundations of the building.

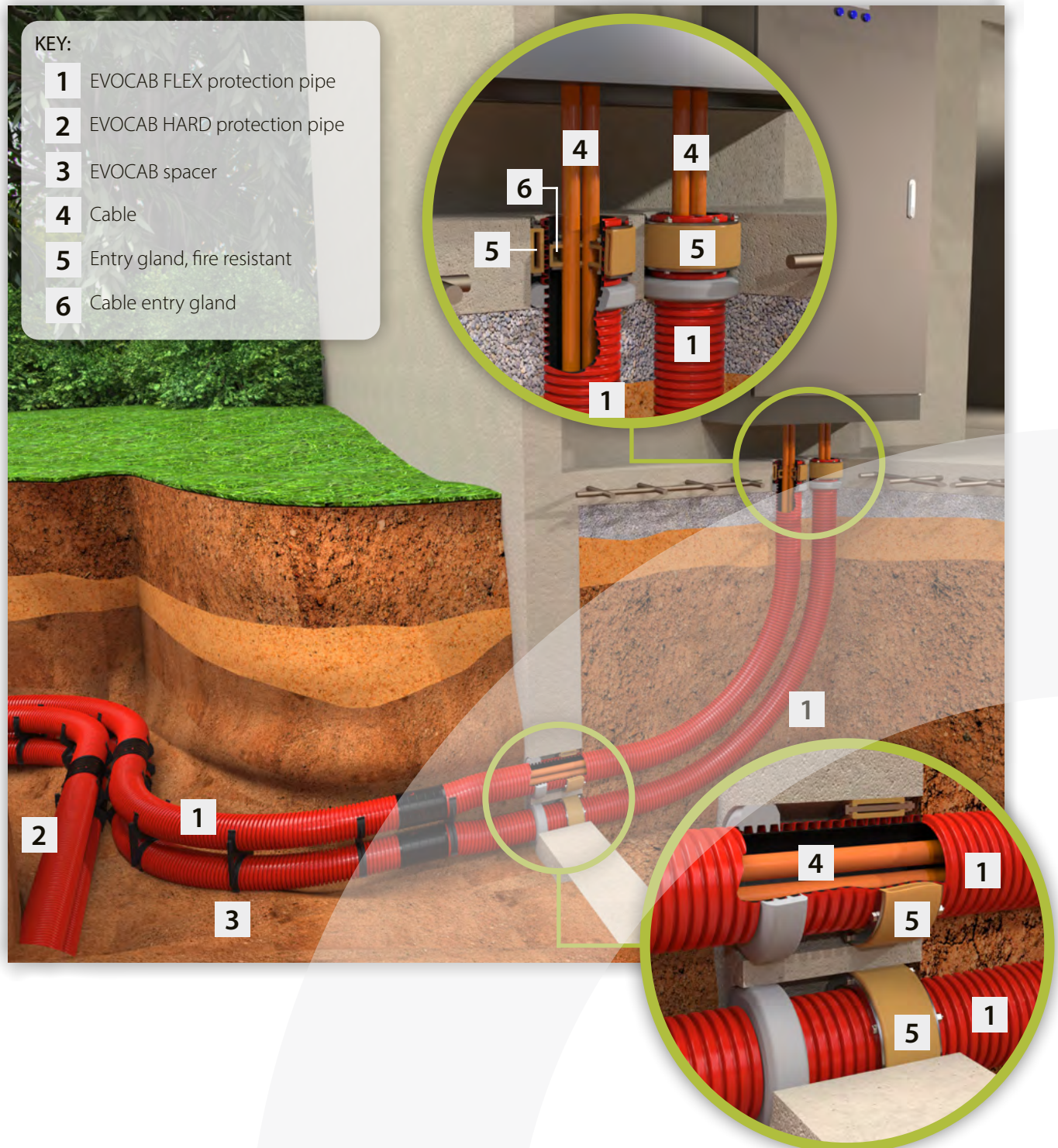

KEY:

- 1 EVOCAB FLEX protection pipe
- 2 EVOCAB HARD protection pipe
- 3 EVOCAB spacer
- 4 Cable
- 5 Entry gland, fire resistant
- 6 Cable entry gland



Example of installation of cable entry through the foundations of the building at the basement.

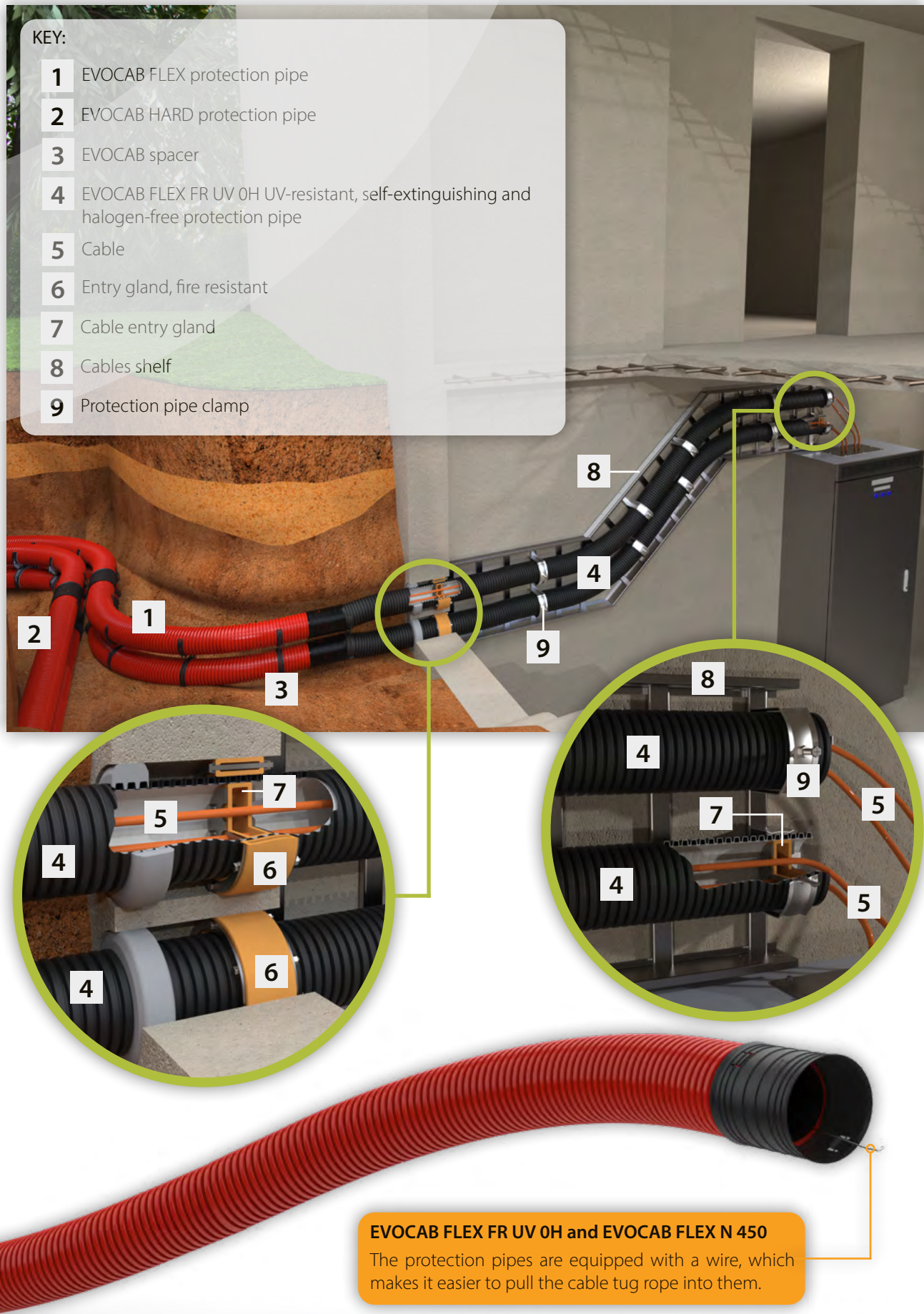

KEY:

- 1 EVOFLEX protection pipe
- 2 EVOFLEX HARD protection pipe
- 3 EVOFLEX spacer
- 4 EVOFLEX FR UV 0H UV-resistant, self-extinguishing and halogen-free protection pipe
- 5 Cable
- 6 Entry gland, fire resistant
- 7 Cable entry gland
- 8 Cables shelf
- 9 Protection pipe clamp

**EVOFLEX FR UV 0H and EVOFLEX N 450**  
The protection pipes are equipped with a wire, which makes it easier to pull the cable tug rope into them.



# GUIDELINES FOR THE INSTALLATION OF CABLE PROTECTION PIPE

## Installation of a horizontally straight or gently curved protection pipeline route in a trench

Build the protection pipes in a straight line and avoid bends in the pipes and fasten them.

Inaccurate, tortuous and uneven construction of the pipe route makes it difficult to pull in cables, increases pulling resistance, creates friction and risks of cable damage.

In order to ensure an optimal construction of the protection pipe in the trench, the requirements of clause 3 of the standard EN 1610 must be followed.



Cross section of the protection pipe trench (according to clause 3, Figure 1, EN 1610 standard)

### LEGEND:

- 1.1** Trench bottom;
  - 1.2** Trench walls or side supports;
  - 1** Lower bedding;
  - 2** Upper bedding, (see Table 3);
  - 3** Sidefill;
  - 4** Initial backfill;
  - 5** Main backfill;
  - 6** The construction part of the road or railway surface, if there is one at the installation place of the protection pipeline (the installation works of this part must be carried out in accordance with the regulations issued by the manager of the road or railway construction infrastructure);
  - 7** Surface;
- OD** – Protection pipe outside diameter;
- a** – Thickness of lower bedding;
- b** – Thickness of upper bedding, (see Table 5);
- c** – Thickness of initial backfill;
- L/2** - The minimum working space in the area between the protection pipe and the trench wall or the support if present, (see Table 4);
- B = OD + L** - Minimum trench width, (see Table 6);
- H1** – Depth of bedding;
- H2** – Depth of embedment in the area around the protection pipe;
- H3** – Depth of cover above the protection pipe;
- Hk** – Trench depth.

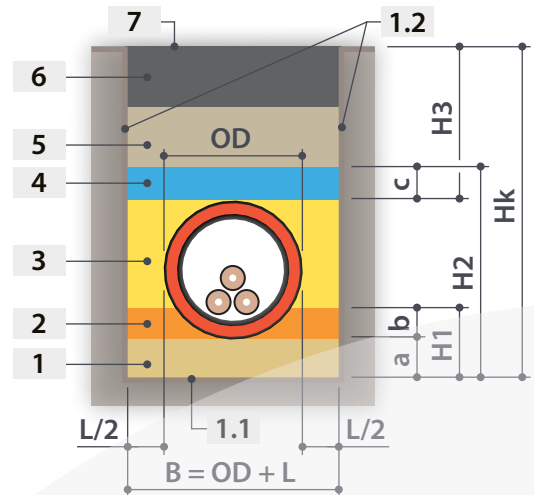

### NOTE:

1. Excavation and installation works of the protection pipe trench must be carried out in accordance with the requirements set forth in the standards EN 1610 and CEN/TR 1046
2. Excavation and reinforcement of the protection pipeline trench must be carried out in accordance with the requirements set forth in clauses 5 and 6 of the standard EN 1610.



## The protection pipe fastening bedding construction type 1 in the trench, compiled in accordance with clause 7.2.1, Figure 3 of the standard EN 1610

According to clause 7.2.1 of the standard EN 1610 recommended minimum thickness filling layer of the lower bedding **a**:

- ▶ 100 mm in usual soil conditions;
- ▶ 150 mm in rock or hard soil conditions.

The thickness (height) of upper bedding filling layer **b** results from the filling layer or the bedding angle **α** (chosen during the design process), which can also be expressed as  $b = k \times OD$ , see clause 3, Figure 1 of the standard EN 1610. Where **k** is a dimensionless coefficient which linking the thickness of the upper bedding filling layer to the of protection pipe outer diameter **OD**. In the national standards of individual countries, it is expressed taking into account the upper bedding embankment support angle **α**.

According to clause 7.1 of the standard EN 1610 recommended minimum thickness of the initial backfill layer **c**:

- ▶ 150 mm above protection pipe along its entire length;
- ▶ 100 mm above protection pipe joint zone.

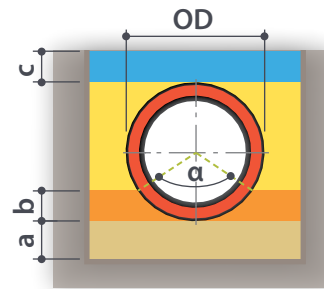

### NOTE:

The bedding angle **α**, which is  $b = k \times OD$  is not the bedding reaction angle used in structural design stage of the construction project, when performing the static calculations of the protection pipe.

In the below Table 3 shows the relationship between the minimum thickness of the upper bedding layer **b** and upper bedding embankment support angle **α**, which EVOPIPES recommends for the installation of a protection pipe system in a trench.

Table 3

Table with recommended thicknesses of upper bedding filling layer for the protection pipe system <b>b</b>			
Protection pipe outside diameter OD	Upper bedding support angle of embankment <b>α</b> , which is: $b = k_n \times OD$		
	90°	120°	180°
	$k_{90} = 0,15$	$k_{120} = 0,25$	$k_{180} = 0,50$
mm	mm	mm	mm
40	6,00	10,00	20,00
50	7,50	12,50	25,00
63	9,45	15,75	31,50
75	11,25	18,75	37,50
90	13,50	22,50	45,00
110	16,50	27,50	55,00
125	18,75	31,25	62,50
160	24,00	40,00	80,00
200	30,00	50,00	100,00
250	37,50	62,50	125,00
315	47,25	78,75	157,50
400	60,00	100,00	200,00



## Minimum trench width

The minimum width of the trench should be such as to provide the minimum total working space in the trench. The minimum trench width values are given in Table 4, which is compiled according to clause 6.3.2, Table 1 of the standard EN 1610, but the minimum trench width depending on the trench depth is given in Table 5 according to clause 6.3.2, Table 2 of the standard EN 1610.

There may also be exceptions to the minimum trench

width listed in Tables 4 and 5. The minimum trench width can be changed under the following conditions:

- ▶ if it is not intended to enter the trench during the installation, for example, automatic or mechanical installation technologies are used;
- ▶ if during installation it is not planned to stand between the protection pipeline and the wall of the trench;
- ▶ in situations of imminent limitation.

Table 4

Protection pipe outside diameter OD	Minimum trench width $B = OD + L$ , m								
	Supported trench			Unsupported trench					
				$\beta \geq 60^\circ$			$\beta \leq 60^\circ$		
	L/2	OD + L	B	L/2	OD + L	B	L/2	OD + L	B
mm	m	m	m	m	m	m	m	m	m
40	0,2	0,04+0,4	0,44	0,2	0,04+0,4	0,44	0,2	0,04+0,4	0,44
50	0,2	0,05+0,4	0,54	0,2	0,05+0,4	0,54	0,2	0,05+0,4	0,54
63	0,2	0,063+0,4	0,463	0,2	0,063+0,4	0,463	0,2	0,063+0,4	0,463
75	0,2	0,075+0,4	0,475	0,2	0,075+0,4	0,475	0,2	0,075+0,4	0,475
90	0,2	0,09+0,4	0,49	0,2	0,09+0,4	0,49	0,2	0,09+0,4	0,49
110	0,2	0,11+0,4	0,51	0,2	0,11+0,4	0,51	0,2	0,11+0,4	0,51
125	0,2	0,125+0,4	0,525	0,2	0,125+0,4	0,525	0,2	0,125+0,4	0,525
160	0,2	0,16+0,4	0,56	0,2	0,16+0,4	0,56	0,2	0,16+0,4	0,56
200	0,2	0,2+0,4	0,6	0,2	0,2+0,4	0,6	0,2	0,2+0,4	0,6
250	0,25	0,25+0,5	0,75	0,25	0,25+0,5	0,75	0,2	0,25+0,4	0,65
315	0,25	0,315+0,5	0,815	0,25	0,315+0,5	0,815	0,2	0,315+0,4	0,715
400	0,35	0,4+0,7	1,1	0,35	0,4+0,7	1,1	0,2	0,4+0,4	0,8

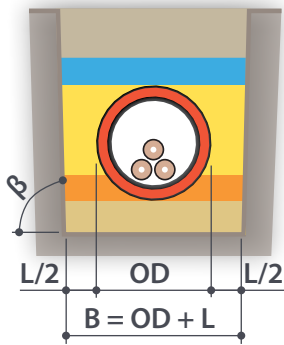

Values L/2 or 0,5 x L equals the minimum working space between the protection pipe and the trench wall or the support if present.

Where:

OD - is the protection pipe outside diameter;

$\beta$  - is the angle of unsupported trench side measured to the horizontal.

Table 5

Trench depth $H = h + OD$	Minimum trench width $b$
m	m
< 1,00	is not regulated
$\geq 1,00 \leq 1,75$	0,80
$\geq 1,75 \leq 4,00$	0,90
> 4,00	1,00

Where:

$H = h + OD$  - is the total trench depth, m;

OD - is the protection pipe outside diameter, m;

h - is the trench depth above protection pipe, m.

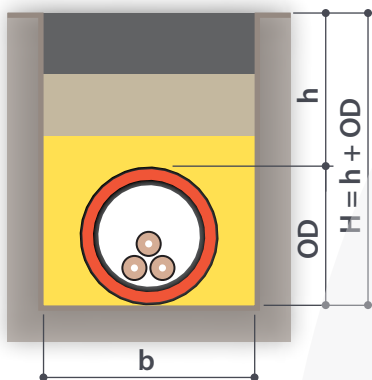



## Installation at low temperatures



The use of frozen ground materials is not allowed.

In winter, at low temperatures, the outside air temperature in the open trench is lower than on the ground surface. Care must be taken so that the bottom of the trench does not freeze. If necessary, to prevent it from freezing, it should be covered with thermal insulation material.

During the winter period, the protection pipe must not

be installed in a trench on frozen ground. If the bottom of the trench is frozen, unfrozen sand or fine-grained sand must be poured on top of it, maintaining the depth of the protection pipeline installation provided in the project.

At an outside air temperature lower than  $-15\text{ }^{\circ}\text{C}$ , special care must be taken when performing assembly and installation work with protection pipes made of polymer material, because impact resistance decreases as the outside air temperature drops. When joining the protection pipes, care must be taken to ensure that there is no ice inside the protection pipe socket.

## Joint of protection pipes

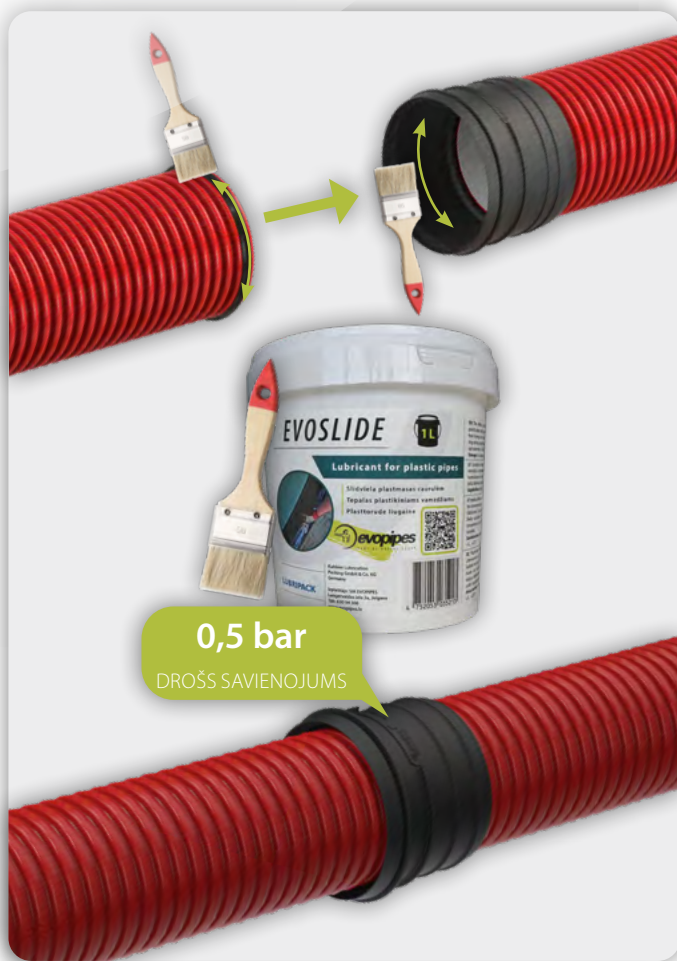

To create a hermetically safe joint between protection pipes, a rubber sealing ring is used, which ensures water tightness of the joint zone/place (up to 0.5 bar).

A brief description of the protection pipe jointing process:

- ✓ Before joint the protection pipe, measure the insertion depth into the socket and mark it with a permanent marker on the end of the protection pipe that will be inserted into the socket;

This mark will enable the correct insertion of the protection pipe up to the stop (end) and will act as a control mechanism to guarantee that the joint is tight and hermetically secure.

- ✓ Make sure the inner surface of the socket is clean. Make sure the end of the protection pipe to be inserted with the rubber sealing ring is clean;
- ✓ When connecting the protection pipes to each other, a lubricant should be used as a means of facilitating the jointing process. For this purpose, use a specially designed lubricant;

### NOTE:

It is forbidden to use oils and lubricants not intended for this purpose!

- ✓ Using a brush, lubricate the inner surface of the socket or the rubber sealing ring along the flange with lubricant. Jointing the protection pipes together up to the stop or mark.

## Trench bedding



The protection pipe needs even support throughout its length provided by the bedding layer. To provide this support, the bedding course should normally be between 100 mm and 150 mm but not less than 50 mm thick. The material used must be granular, such as gravel, sand or crushed rock, and meet the same requirements as the soil material used as the embedment soil material in the area around the protection pipe.

The ground filling material used for trench filling (backfilling) in the area around the protection pipe must comply with subclauses 5.3 of the standard EN





1610 to the requirements set forth in order to ensure the carrying capacity and stability of the installed protection pipeline in the ground.

The excavated soil material can be used to backfill the trench, if it meets the requirements set forth in Table A.1 of Annex A of the standard CEN/TR 1046 for the soil material to be used as backfill. The selection criteria of the soil material and its suitability for use in the trench as a backfill soil material and its filler material are given below in Table 6.



Table 6

Soil type	Soil group					To be used as backfill
	No.	Typical name	Symbol*	Distinguishing mark	Example(s)	
Granular	G1	Single-sized gravel	(GE) [GU]	Steep granulation line, predominance of one-grain-size zone	Crushed rock, river and beach gravel, morainic gravel, scoria, volcanic ash	YES
		Well-graded gravels, gravel-sand mixtures	[GW]	Continuous granulation line, several grain-size zones		
		Poorly graded gravel- sand mixtures	(GI) [GP]	Steplike granulation line, one or more absent grain zones		
	G2	Single-sized sands	(SE) [SU]	Steep granulation line, predominance of one grain size zone	Dune and drift sand, valley sand, basin sand	YES
		Well-graded sands, sand-gravel mixtures	[SW]	Continuous granulation line, several grain size zones	Morainic sand, terrace sand, beach sand	
		Poorly graded sand-gravel mixtures zones	(SI) [SP]	Steplike granulation line, one or more absent grain zones		
Granular	G3	Silty gravels, poorly graded gravel-sand-silt mixtures	[GM] (GU)	Broad/intermittent granulation line with fine grained silt	Weathered gravel, slope debris, clayey gravel	YES
		Clayey gravels, poorly graded gravel-sand-clay mixtures	[GC] (GT)			
		Silty sands, poorly graded sand-silt mixtures	[SM] (SU)	Broad/intermittent granulation line with fine grained silt	Liquid sand, loam, sand loess	
		Clayey sands, poorly graded sand-clay mixtures	[SC] (ST)	Broad/intermittent granulation line with fine grained clay	Loamy sand, alluvial clay, alluvial marl	
Cohesive	G4	Inorganic silts, very fine sands, rock flour, silty or clayey fine sands	[ML] (UL)	Low stability, rapid reaction, nil to slight plasticity	Loess, loam	YES
		Inorganic clay, distinctly plastic clay	[CL] (TA) (TL) (TM)	Medium to very high stability, no to slow reaction, low to medium plasticity	Alluvial marl, clay	

\* - The symbols used are taken from two sources.

Symbols in square brackets [...] are taken from British Standard BS 5930.

Symbols in round brackets (...) are taken from German Standard DIN 18196.

**NOTE:**

Where a soil is mixture of types, then whichever is the predominant one present can be used for the classification.

The information provided in the table corresponds to Table A.1 of Annex A of the standard CEN/TR 1046.



## Backfilling of the trench

The backfill area of the protection pipe shall be created in layers on each side of the protection pipe and compacted to the required degree of compaction, unless otherwise specified in the design specification. The backfill above the protection pipe is created by dividing it into rough layers and compacting them to the same degree of compaction as the area around the protection pipe.

Pour a layer of soil up to 30 cm thick, without impurities containing stone material (maximum size of the soil aggregate fraction mixture 20 mm), on both sides of the protection pipe.

If the soil material thickness of initial backfill layer is  $\leq 15$  cm compaction works of soil bedding material in the above the protection pipe zone should be done manually (using a foot or hand tamper with a weight of min. 15 kg). Mechanical compaction works of the soil filling material can be performed when the backfill material above the upper surface of the protection pipe is at least 30 cm thick ( zone **1** ).

- ▶ The total soil material thickness of backfill layer in the trench immediately above the protection pipe required before mechanical soil compaction depends on the type of compaction equipment used and the soil material backfill of the group type used;
- ▶ During the filling of the trench with backfill material do not push the protection pipes to sides of the trench;
- ▶ During trench filling, in order not to change the position of the protection pipes and to prevent bends and indentations, if necessary, fix the protection pipes by fastening them.

### ATTENTION!

When carrying out soil material compaction basic works in the trench above the protection pipe zone using heavy compaction technique ( $>0.60$  kN), the following conditions must be observed: in the zone above the protection pipe, there must be  $\geq 30$  cm thick a top layer of the soil material filling embedment, but in the zone above the protection pipe joint  $\geq 20$  cm.

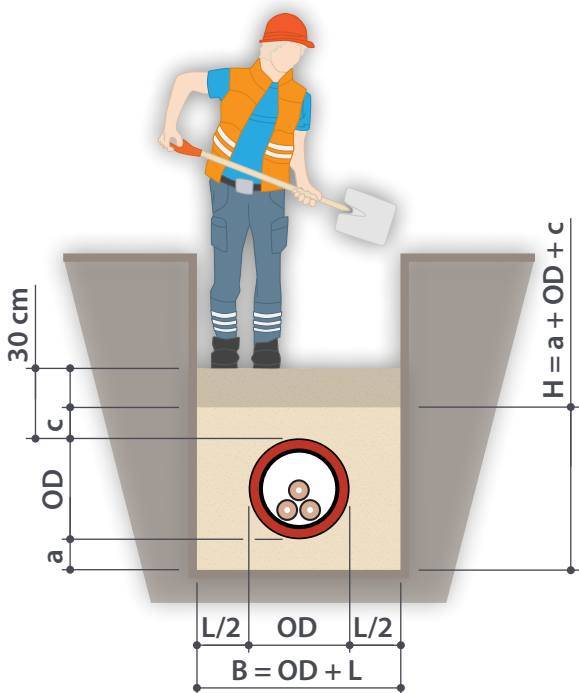

### LEGEND:

**OD** - Protection pipe outside diameter, mm;

**B = OD + L** - Minimum trench width, (see Table 6), m;

**L/2 vai 0,5 x L** - The minimum working space in the area between the protection pipe and the trench wall or the support if present, (see Table 4), m;

### NOTE:

The minimum thickness of initial backfill layer **c**:

- ▶ 150 mm above protection pipe along its entire length;
- ▶ 100 mm above protection pipe joint zone.

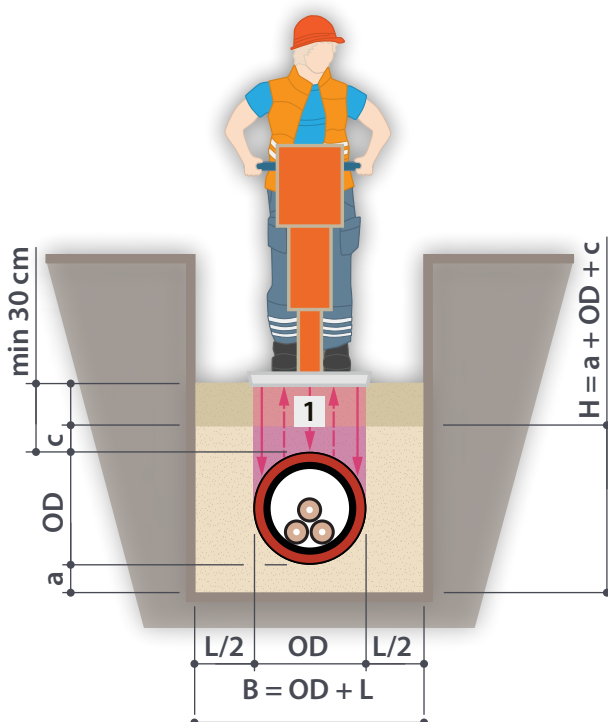

**a** - Minimum thickness of lower bedding filling layer, mm;

**c** - Minimum thickness of initial backfill layer, mm;

**1** - The top layer zone of the embankment layer above the protection pipe;

**H = a + OD + c** - Depth of embedment in the area around the protection pipe, mm.

The minimum thickness of lower bedding filling layer **a**:

- ▶ 100 mm in usual soil conditions;
- ▶ 150 mm in rock or hard soil conditions.



## Special protective measures

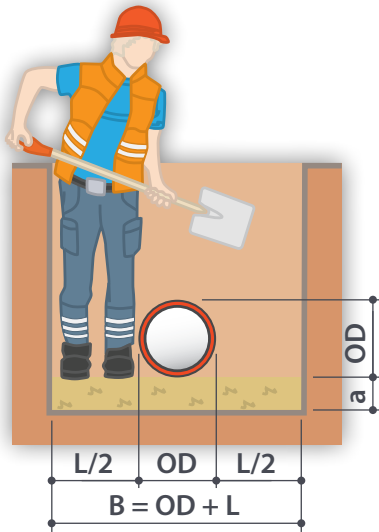

Precautions shall be taken during installation to avoid takeoffs and offsets of the protection pipe when soil material is filled under the edges of the protection pipe.

With the exception of trench support walls or fasteners, be careful, from collapse of the compacted soil material.

During the process of backfilling the trench, protect the protection pipe from falling objects and compaction equipment the of direct exposure or other objects, which may cause damage. If the backfill material needs to be compacted to the ground surface, do not use compaction equipment directly over the protection pipe up to not has been applied sufficient a lay amount of backfill material. Do not use rolling equipment or heavy tampers to compact end backfill before the top surface of the outer diameter of the protection pipe has been provided with at least the minimum backfill thickness, which is specified below in Table 7.

### LEGEND:

**OD** - Protection pipe outside diameter, mm;

**B = OD + L** - Minimum trench width, (see Table 6), m;

**L/2 vai 0,5 x L** - The minimum working space in the area between the protection pipe and the trench wall or the support if present, (see Table 4), m;

**a** - Minimum thickness of lower bedding filling layer, mm.

### NOTE:

The minimum thickness of lower bedding filling layer **a**:

- ▶ 100 mm in usual soil conditions;
- ▶ 150 mm in rock or hard soil conditions.

If the designer has determined the required level of compaction, it must be ensured that whether compaction is possible before placing the protection pipe.

In the traffic area, the final fill material must be compactable and in should be compacted to at least  $\geq 95\%$  amounting of the Standard Density after Proctor.

If the trench is excavated in the green area directly next to the roadway or under the roadway, filling the trench and compacting the fill must be done in accordance with the requirements set for the traffic area.

In other cases, the filling should be compacted to the density of the surrounding soil. The trench must be filled in such a way that later in the self-compaction process it reaches the height provided for in the project or is level with the ground surface.

### NOTE:

The assembly of the protection pipeline, as well as the installation of the leveling layer and embankment, must take place in a dry trench.

## Compaction of filling

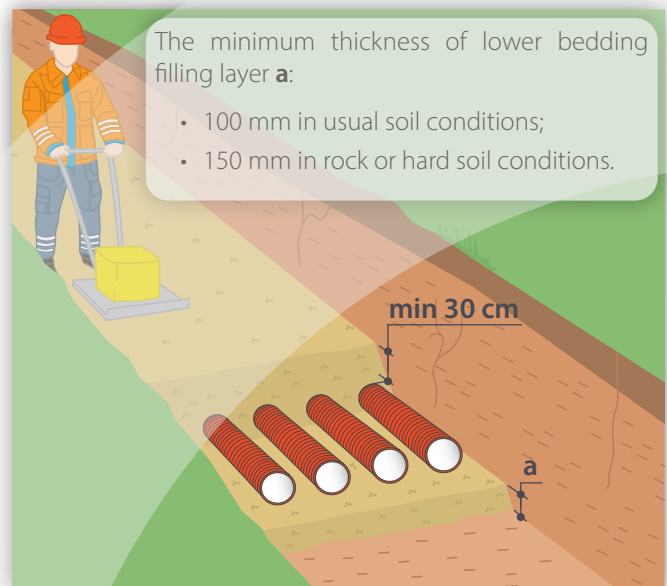

The minimum thickness of lower bedding filling layer **a**:

- 100 mm in usual soil conditions;
- 150 mm in rock or hard soil conditions.

min 30 cm

a



## Recommended compaction methods

Below in Table 7 has been specified the maximum recommended thickness of the layer above the protection pipe and the required (recommended) number of passes to achieve the specified compaction class of the soil material with different compaction equipment, for different groups (types) of soil materials.

In addition, it also includes the minimum recommended filling material thickness layer over the protection pipe to make sure whether equipment in question is usable.

Below in Table 7, the information is presented in the form of a recommendation and it is recommended to conduct trials using various combinations of the above in order to choose the most appropriate kind of combination to achieve the result.

Table 7

Equipment	Number of passes for compaction class		Maximum layer thickness, in meters, after compaction for soil material group				Minimum thickness over protection pipe crown before compaction (initial backfill), in meters
			Soil material groups				
	Well - W	Moderate - M	G1	G2	G3	G4	
<b>Foot or hand tamper</b>							
min. 15 kg	3	1	0,15	0,10	0,10	0,10	0,20
<b>Vibrating tamper</b>							
min. 70 kg	3	1	0,30	0,25	0,20	0,15	0,30
<b>Plate vibrator:</b>							
min. 50 kg	4	1	0,10	-	-	-	0,15
min. 100 kg	4	1	0,15	0,10	-	-	0,15
min. 200 kg	4	1	0,20	0,15	0,10	-	0,20
min. 400 kg	4	1	0,30	0,25	0,15	0,10	0,30
min. 600 kg	4	1	0,40	0,30	0,20	0,15	0,50
<b>Vibrating roller:</b>							
min. 15 kN/m	6	2	0,35	0,25	0,20	-	0,60
min. 30 kN/m	6	2	0,60	0,50	0,30	-	1,20
min. 45 kN/m	6	2	1,00	0,75	0,40	-	1,80
min. 65 kN/m	6	2	1,50	1,10	0,60	-	2,40
<b>Twin vibrating roller:</b>							
min. 5 kN/m	6	2	0,15	0,10	-	-	0,20
min. 10 kN/m	6	2	0,25	0,20	0,15	-	0,45
min. 20 kN/m	6	2	0,35	0,30	0,20	-	0,60
min. 30 kN/m	6	2	0,50	0,40	0,30	-	0,85
<b>Triple heavy roller (on vibration)</b>							
min. 50 kN/m	6	2	0,25	0,20	0,20	-	1,00

### Where:

- G1 – non-cohesive granular soil material (e.g. sand, gravel);
- G2 – easily cohesive mixed granular soil material (e.g. cohesive sand, gravel);
- G3 – cohesive mixed granular soil material (e.g. coarse sand);
- G4 – cohesive soil material (e.g. clay).

The information provided in the table corresponds to Table 5 of the standard CEN/TS 1046.



## Main backfill

The main backfill part of the backfill can be created using the excavated soil material with a maximum stone particle size of up to 30 mm, with rule provided that filling layer of at least 30 cm thick is provided above the protection pipe. If compaction of the main backfill is required, the material shall be suitable for compaction and shall have a maximum particle size not greater than 2/3 of the compaction layer thickness.

- ▶ Under areas where there is no traffic load, in considered suitable is compaction class (Not) **N**.
- ▶ Under areas with traffic load used compaction class (Well) **W**.

Recommended layer thickness and number of compaction strokes in the installation of protection pipes, see Table 7.

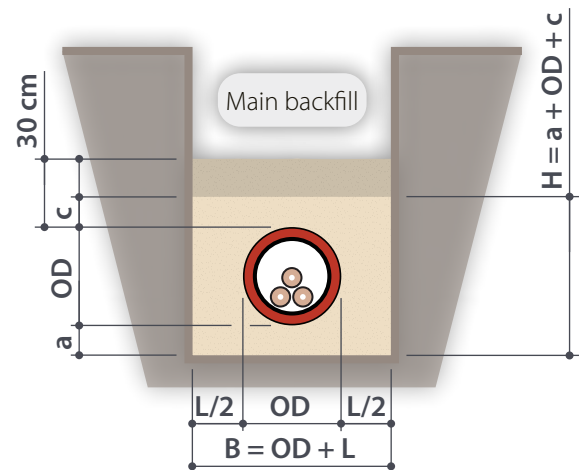

### LEGEND:

**OD** - Protection pipe outside diameter, mm;

**B = OD + L** - Minimum trench width, (see Table 6), m;

**L/2 or 0,5 x L** - The minimum working space in the area between the protection pipe and the trench wall or the support if present, (see Table 4), m;

**a** - Minimum thickness of lower bedding filling layer, mm;

**c** - Minimum thickness of initial backfill layer, mm;

**H = a + OD + c** - Depth of embedment in the area around the protection pipe, mm.

### NOTE:

The minimum thickness of initial backfill layer **c**:

- ▶ 150 mm above protection pipe along its entire length;
- ▶ 100 mm above protection pipe joint zone.

The minimum thickness of lower bedding filling layer **a**:

- ▶ 100 mm in usual soil conditions;
- ▶ 150 mm in rock or hard soil conditions.

## Compaction quality control

Soil compaction works in the trench must be carried out in accordance with the requirements set forth in Table 5 of the standard CEN/TR 1046, (see Table 7).

For recommendations and suggestions on how to choose an appropriate compaction work method to achieve an appropriate compaction class, see in clause 7.2.7.4 of the standard CEN/TR 1046.

Quality control of compaction works must be carried out in accordance with the requirements set forth in

clause 7.2.7.6 of the standard CEN/TR 1046.

Conformity with the design assumptions should be confirmed by one or more of the following methods:

- ✓ close monitoring of the backfill procedures;
- ✓ verification of the initial deformation (ovality) of the installed protection pipe;
- ✓ on-site verification of the degree of compaction.

## Soil density after installation

The degree of soil compaction depends on the material chosen for filling the trench, as well as on whether the protection pipe will be installed in an area with traffic load or without traffic load. This is necessary to ensure the necessary strength and stability of the construction of the protection pipe during its operation, as well as to prevent soil settling as a result of soil self-compaction.

According to clause 7.2.7.5 of the standard CEN/TR 1046 areas with traffic load it is recommended to choose compaction class (Well) **W**, but in areas without traffic load compaction class (Not) **N**. The compaction class of the soil material is determined after the Standard Proctor Density **SPD**. In the Table 8 is shown compaction classes to the appropriate of the Standard Proctor Density **SPD**.



Table 8

Compaction class	The group of soil fill material to be used for backfilling the trench (according to the standard CEN/TR 1046 in the Table 4 and Annex A classification of soils in the Table A.1)			
	G1	G2	G3	G4
	SPD, %	SPD, %	SPD, %	SPD, %
<b>*Not - N</b>	90 ÷ 94	84 ÷ 89	79 ÷ 85	75 ÷ 80
<b>Moderate - M</b>	95 ÷ 97	90 ÷ 95	86 ÷ 92	81 ÷ 89
<b>Well - W</b>	98 ÷ 100	96 ÷ 100	93 ÷ 96	90 ÷ 95

\* - There is no regulated compaction class

The Standard Proctor Density SPD is determined according to standard DIN 18127, which corresponds to the standard EN 13286-2 .

Where:

- G1 – non-cohesive granular soil material (e.g. sand, gravel);
- G2 – easily cohesive mixed granular soil material (e.g. cohesive sand, gravel);
- G3 – cohesive mixed granular soil material (e.g. coarse sand);
- G4 – cohesive soil material (e.g. clay).

## THE INSTALLATION OF CABLE POWER LINES IN THE CABLE BLOCKS TO BE CONCRETED

For the construction of the cable blocks and mechanical protection of cables protection pipes are used. When constructing the cable blocks, recommends to foresee an opportunity of additional placement of at least 15% reserve from total in the project provided number of cables.

Cable blocks facing the cable chamber direction must have no less than 0.2% down directed slope, to prevent water from accumulating in the cable blocks.

At the places where the cable power lines installed in the cable blocks change direction, as well as in the places where the cables enters the sub surface (ground) from

cable block, cable chambers must be installed to ensure convenient pulling of the cables into the cable blocks and to pulling out from them cables into the cable blocks and to pulling out from them.

The transition of cables from the cable block in the sub surface (ground) is allowed without installing cable chambers, if the number of cables in the cable block does not exceed 10. In this case, the cable exits from the cable block must be sealed with waterproof material.

For the installation of cable power lines through the walls of the buildings, tunnels, basements, and through the walls inside of them, special cable entries must be installed (see page 12).





## An example of the installed cable power lines in a cable block

### LEGEND:

- 1** Lower bedding sand or fine gravel;
- 2** Set in concreted cable block, concrete B15;
- 3** Protection pipe with the filled up cable channel;
- 3R** Protection pipe with recommended spare cable channel;
- 4** EVOCAB (protection pipe) spacer, (see Table 9);
- 5** Main backfill;
- 6** The construction part of the road or railway surface, if there is one at the installation place of the protection pipeline (the installation works of this part must be carried out in accordance with the regulations issued by the manager of the road or railway construction infrastructure);
- 7** Surface;

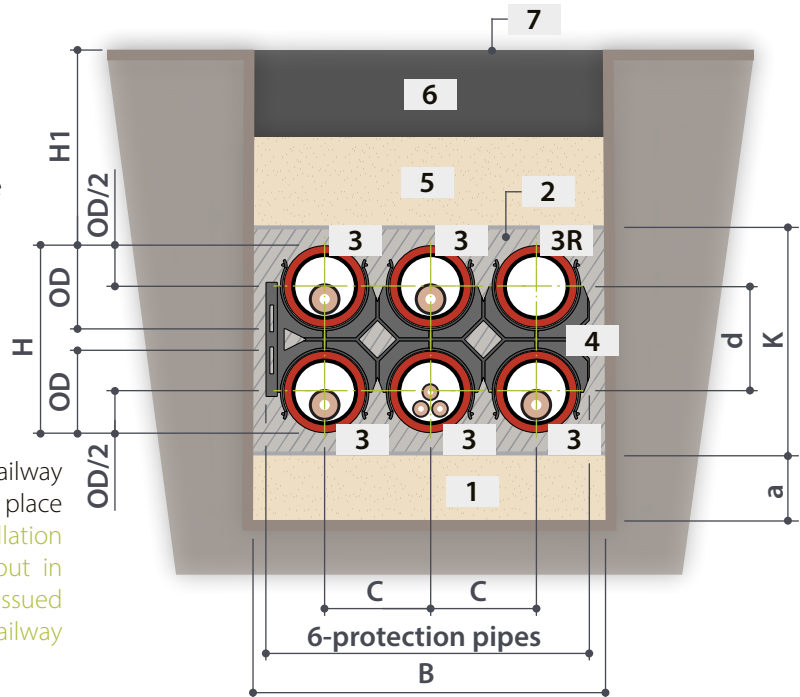

- H1** – The depth of the cable block from the outer surface of the trench to the upper surface of the outer diameter of the protection pipe depends on the installation place and intended surface load class, min 0,2 m;
- d** – EVOCAB (protection pipe) spacer size, (see Table 9);
- H = 2 x (OD/2) + d = OD + d** – The height of the protection pipe of cable block with EVOCAB spacer, (see Table 9);
- OD** – Protection pipe outside diameter, (see Table 9);
- K** – Concrete cable block height;
- a** – Minimum thickness of lower bedding filling layer;
- C** – EVOCAB (protection pipe) spacer size, (see Table 9);
- 6-protection pipes** – EVOCAB (protection pipe) spacer length, (see Table 9);
- B** – Cable block trench width (concrete cable block width).

### NOTE:

The minimum thickness of lower bedding filling layer **a**:

- ▶ 100 mm in usual soil conditions; | ▶ 150 mm in rock or hard soil conditions.





## EVOcab SPACER

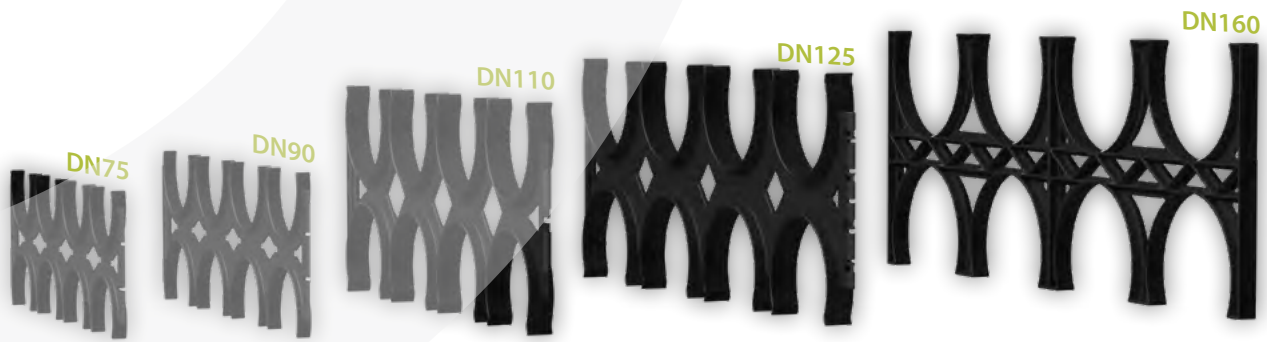

It is recommended to use the spacer in the installation of cable block lines (several layer levels) in order to ensure the same distance between the protection pipes, as well as to ensure the stability of the block during construction

and to prevent the protection pipes from shifting, which can cause deformation of the cable line and subsequent problems in the cable pulling process. See Table 9 for EVOcab spacer dimensions.

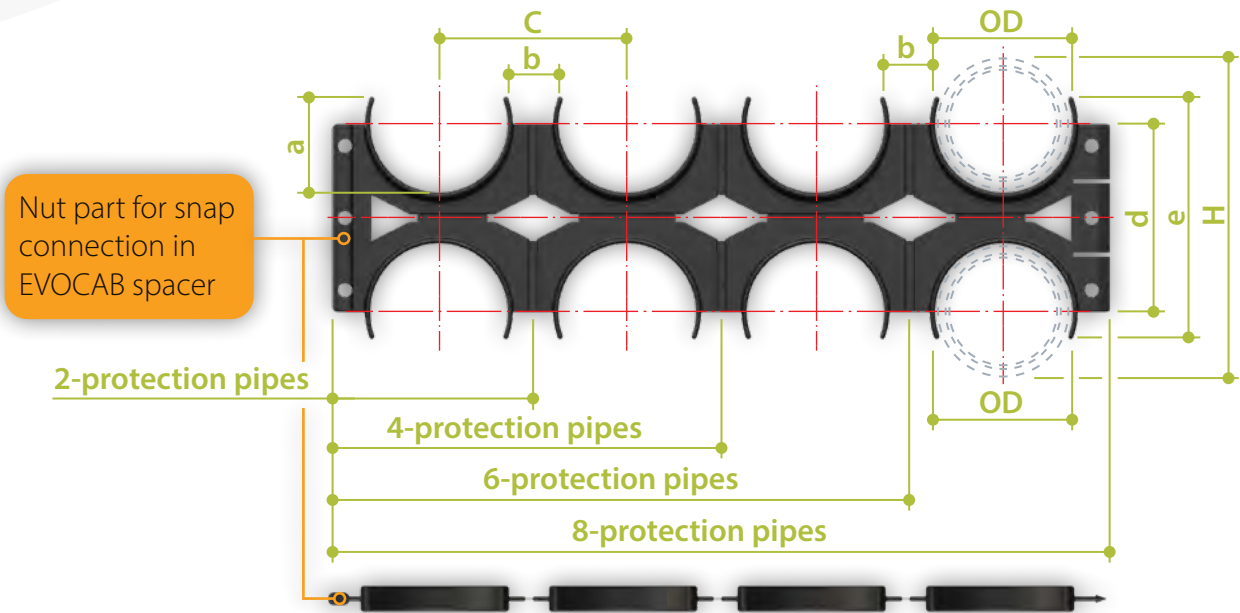

Table 9

Protection pipe nominal diameter size DN, mm	75	90	110	125	160
Protection pipe outside diameter size OD, mm	75	90	110	125	160
$H = OD + d$ , mm	177,6	208	250	287	350
2-protection pipes, mm	109,7	124	147,5	174,3	190
4-protection pipes, mm	212,6	242	287,5	337,9	380
6-protection pipes, mm	315,5	360	427,5	501,5	570
8-protection pipes, mm	425	484	574,99	663,77	760
a, mm	51,6	59,65	90,2	98,12	115
b, mm	27,9	28,2	29	38,6	30
C, mm	102,9	118	140	163,6	190
d, mm	102,6	118	140	162	190
e, mm	130,8	147,5	209,4	233,24	260
Thickness, mm	13,7	14	25	27,8	20
Nut part for snap connection	is equipped	is equipped	is equipped	is equipped	not equipped





Installation sizes of cable block length and height with EVO-CAB spacer and protection pipe when the cable block is built in two levels:

- ▶ from 2-protection pipes, see Table 10;
- ▶ from 4-protection pipes, see Table 11;
- ▶ from 6-protection pipes, see Table 12;
- ▶ from 8-protection pipes, see Table 13.

When the cable block is built in one level:

- ▶ from 2-protection pipes, see Table 14;
- ▶ from 3-protection pipes, see Table 15;
- ▶ from 4-protection pipes, see Table 16.

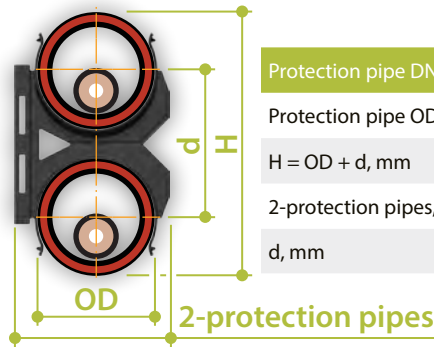

Protection pipe DN, mm	75	90	110	125	160
Protection pipe OD, mm	75	90	110	125	160
H = OD + d, mm	177,6	208	250	287	350
2-protection pipes, mm	109,7	124	147,5	174,3	190
d, mm	102,6	118	140	162	190

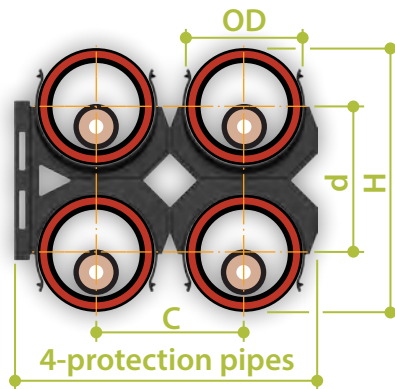

Protection pipe DN, mm	75	90	110	125	160
Protection pipe OD, mm	75	90	110	125	160
H = OD + d, mm	177,6	208	250	287	350
4-protection pipes, mm	212,6	242	287,5	337,9	380
C, mm	102,9	118	140	163,6	190
d, mm	102,6	118	140	162	190

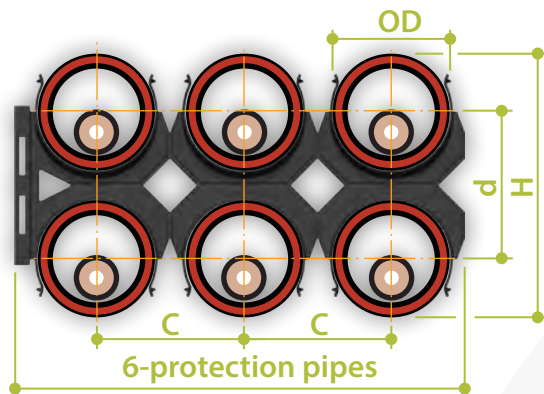

Protection pipe DN, mm	75	90	110	125	160
Protection pipe OD, mm	75	90	110	125	160
H = OD + d, mm	177,6	208	250	287	350
6-protection pipes, mm	315,5	360	427,5	501,5	570
C, mm	102,9	118	140	163,6	190
d, mm	102,6	118	140	162	190

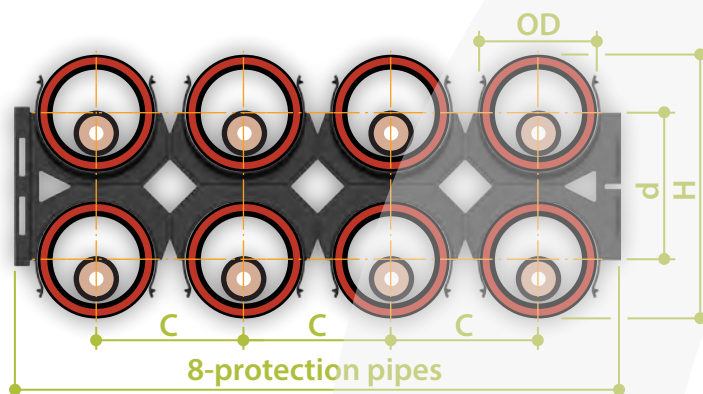

Protection pipe DN, mm	75	90	110	125	160
Protection pipe OD, mm	75	90	110	125	160
H = OD + d, mm	177,6	208	250	287	350
8-protection pipes, mm	425	484	574,99	663,77	760
C, mm	102,9	118	140	163,6	190
d, mm	102,6	118	140	162	190

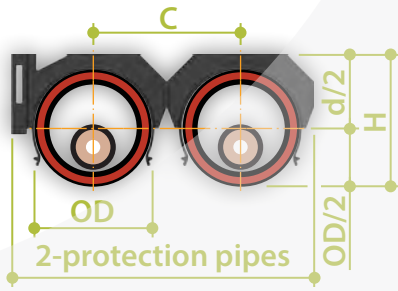

Table 14

Protection pipe DN, mm	75	90	110	125	160
Protection pipe OD, mm	75	90	110	125	160
$H = OD/2 + d/2$ , mm	88,8	104	125	143,5	175
2-protection pipes, mm	212,6	242	287,5	337,9	380
C, mm	102,9	118	140	163,6	190
d/2, mm	51,3	59	70	81	95
OD/2, mm	37,5	45	55	62,5	80

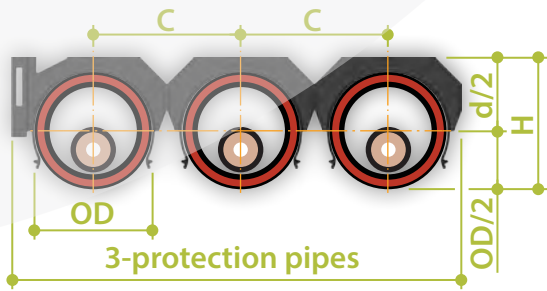

Table 15

Protection pipe DN, mm	75	90	110	125	160
Protection pipe OD, mm	75	90	110	125	160
$H = OD/2 + d/2$ , mm	88,8	104	125	143,5	175
3-protection pipes, mm	315,5	360	427,5	501,5	570
C, mm	102,9	118	140	163,6	190
d/2, mm	51,3	59	70	81	95
OD/2, mm	37,5	45	55	62,5	80

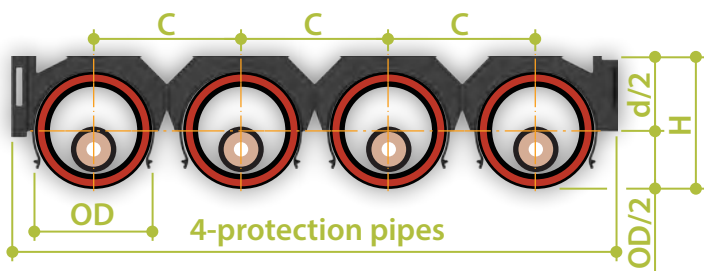

Table 16

Protection pipe DN, mm	75	90	110	125	160
Protection pipe OD, mm	75	90	110	125	160
$H = OD/2 + d/2$ , mm	88,8	104	125	143,5	175
4-protection pipes, mm	425	484	574,99	663,77	760
C, mm	102,9	118	140	163,6	190
d/2, mm	51,3	59	70	81	95
OD/2, mm	37,5	45	55	62,5	80

The recommended placement distance between EVOCAB spacer depends on the type of cable protection pipe used:

- ▶ EVOCAB FLEX N 450 recommended maximum distance between EVOCAB spacer 1,0 m;
- ▶ EVOCAB HARD N 450, EVOCAB HARD N 750, RIGID MULTI PP N 750 and EVOCAB SUPERHARD N 1250 recommended maximum distance between EVOCAB spacer 1,5 m.

**NOTE:**

The straight installed section of the protection pipeline, without deviations in the vertical and horizontal plane, ensures more efficient and safer cable pulling.

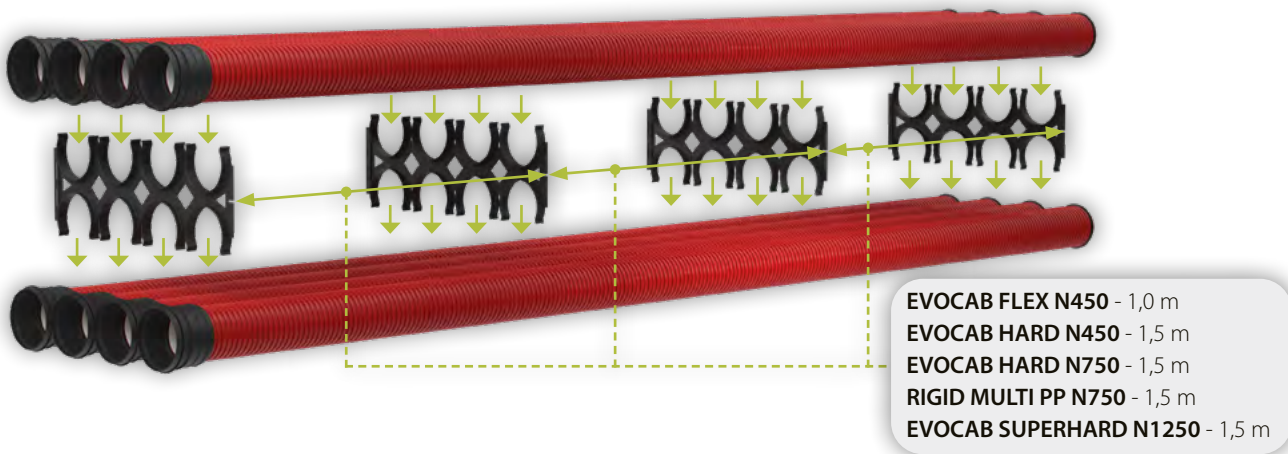

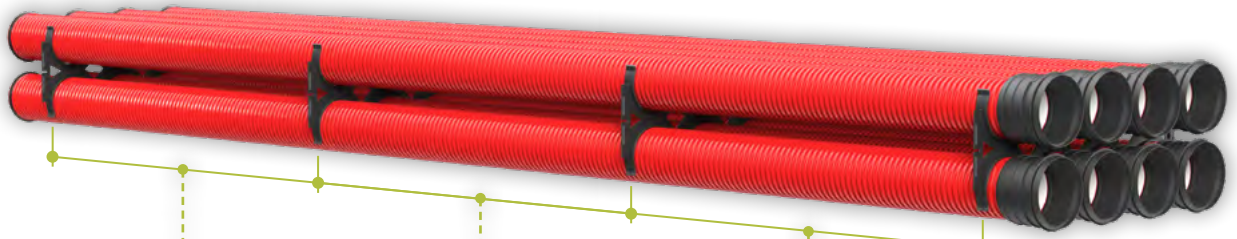

- EVOcab FLEX N450 - 1,0 m
- EVOcab HARD N450 - 1,5 m
- EVOcab HARD N750 - 1,5 m
- RIGID MULTI PP N750 - 1,5 m
- EVOcab SUPERHARD N1250 - 1,5 m

When using EVOcab spacers in the installation of turns in the cable block track, the recommended maximum placement distance between protection pipes is 0,5 m.

In the installation of turns using products of this type, e.g. EVOcab FLEX N 450, EVOcab FLEX FR UV 0H and EVOcab ELBOW N 750, the recommended maximum distance between EVOcab spacer is 0,5 m.

**NOTE:**

The even installed turning section of the protection pipeline route, without deviations in the vertical and horizontal plane, ensures more efficient and safer cable pulling in.

**Maximum distance between EVOcab spacers - 0,5 m**

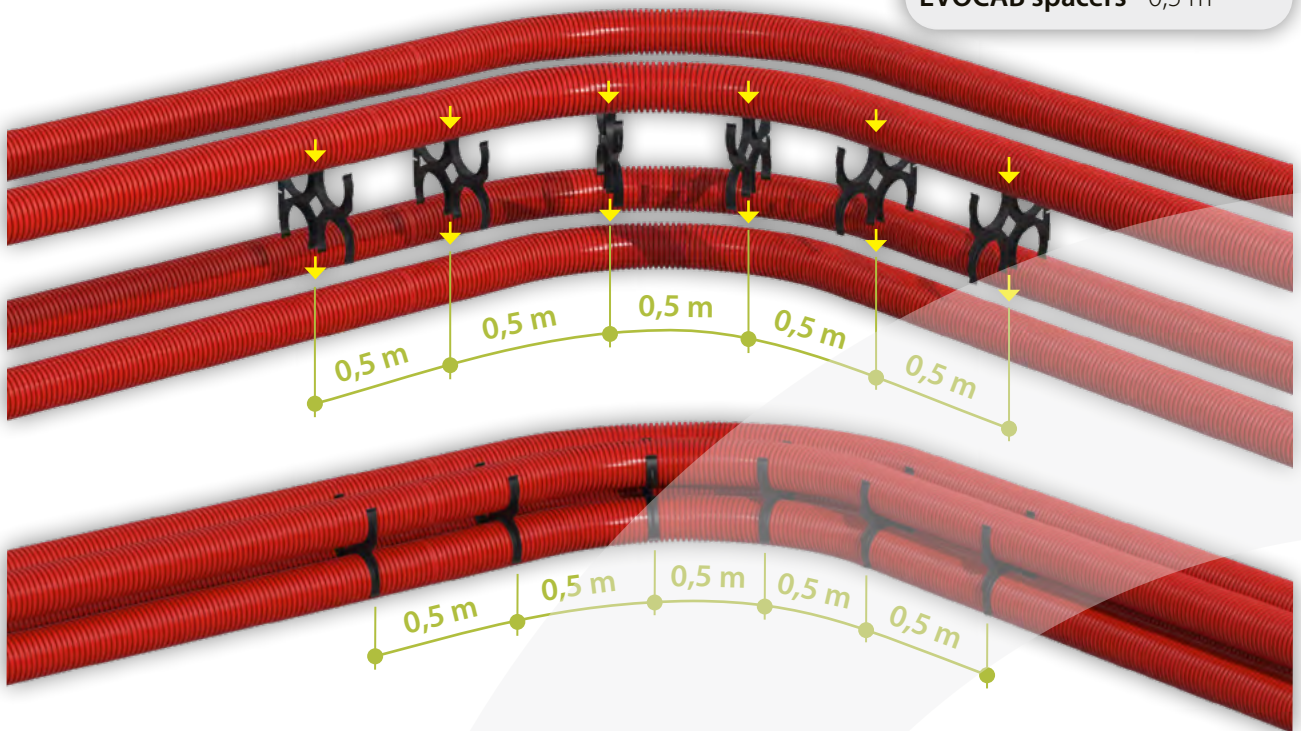

**Connecting EVOcab spacers to one another**

If it is necessary to increase the number of cable blocks to be installed in their length, EVOcab spacers can be conveniently and quickly connected to each other using a nut part for snap connection.

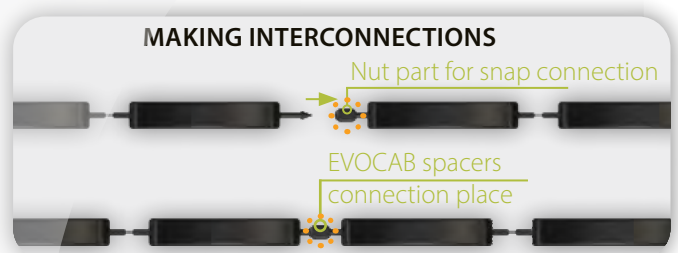



Example of connecting EVOCAB spacers to each other creating a cable block in 2 height levels using EVOCAB spacers  
8-protection pipes + 4-protection pipes = 12-protection pipes

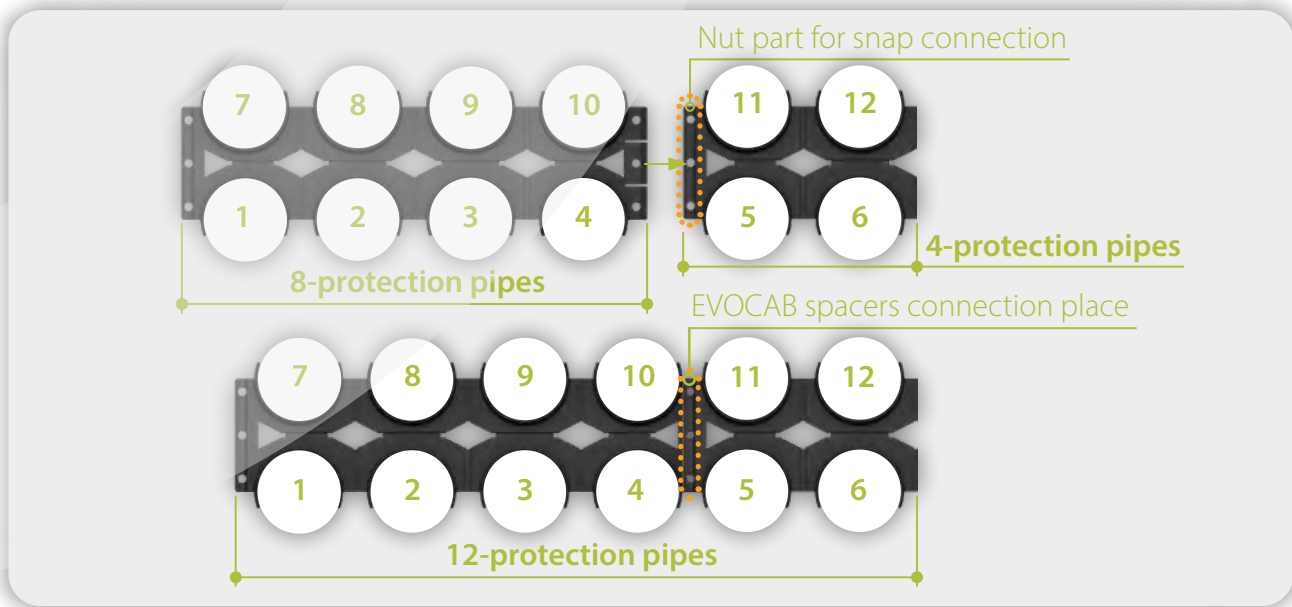

Example of assembly of EVOCAB spacers in a cable block of 12-protection pipes in 3 height levels

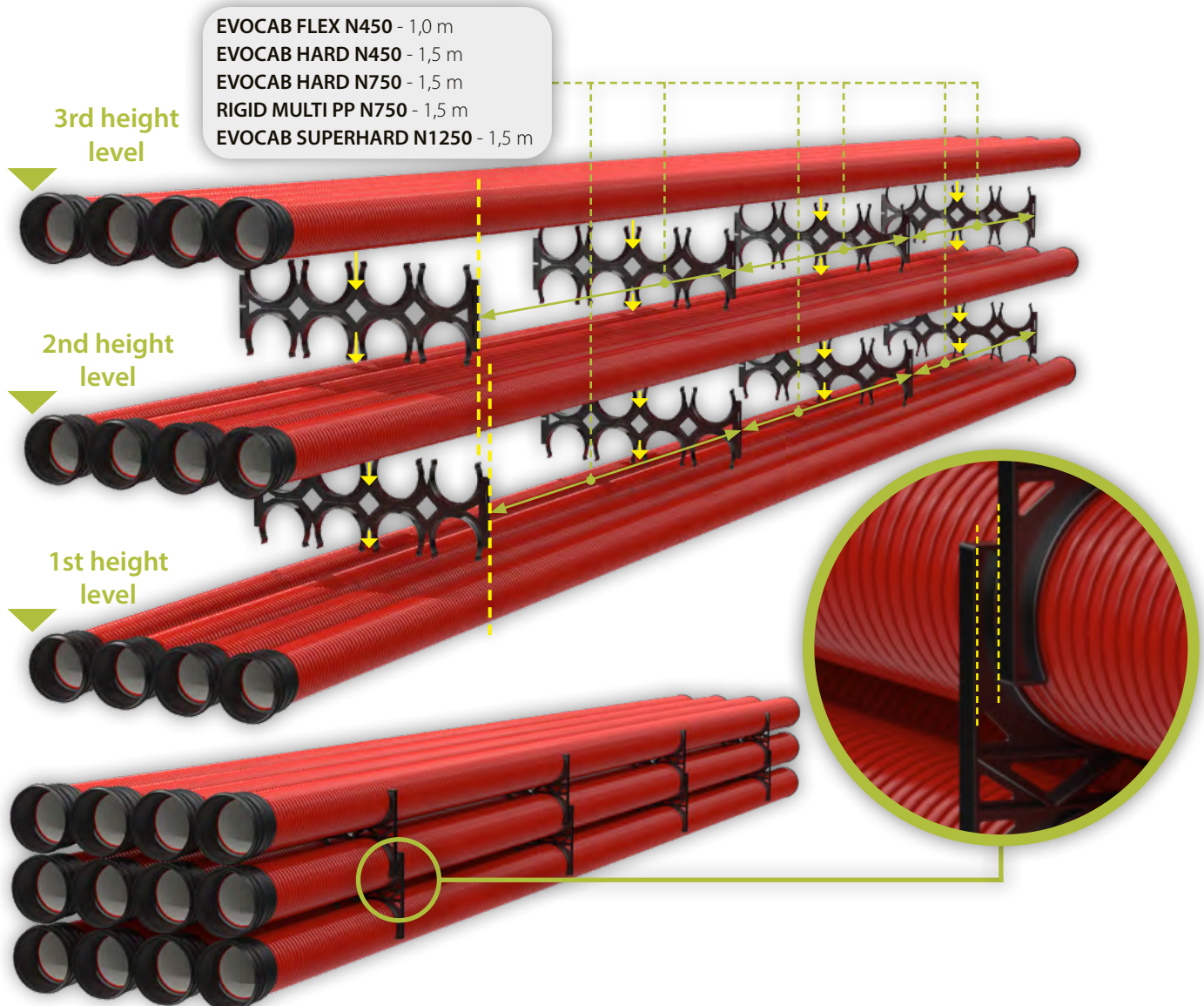



## Example of the installation of a 90° turn of a cable block route with EVOcab FLEX N 450 protection pipes and EVOcab spacers

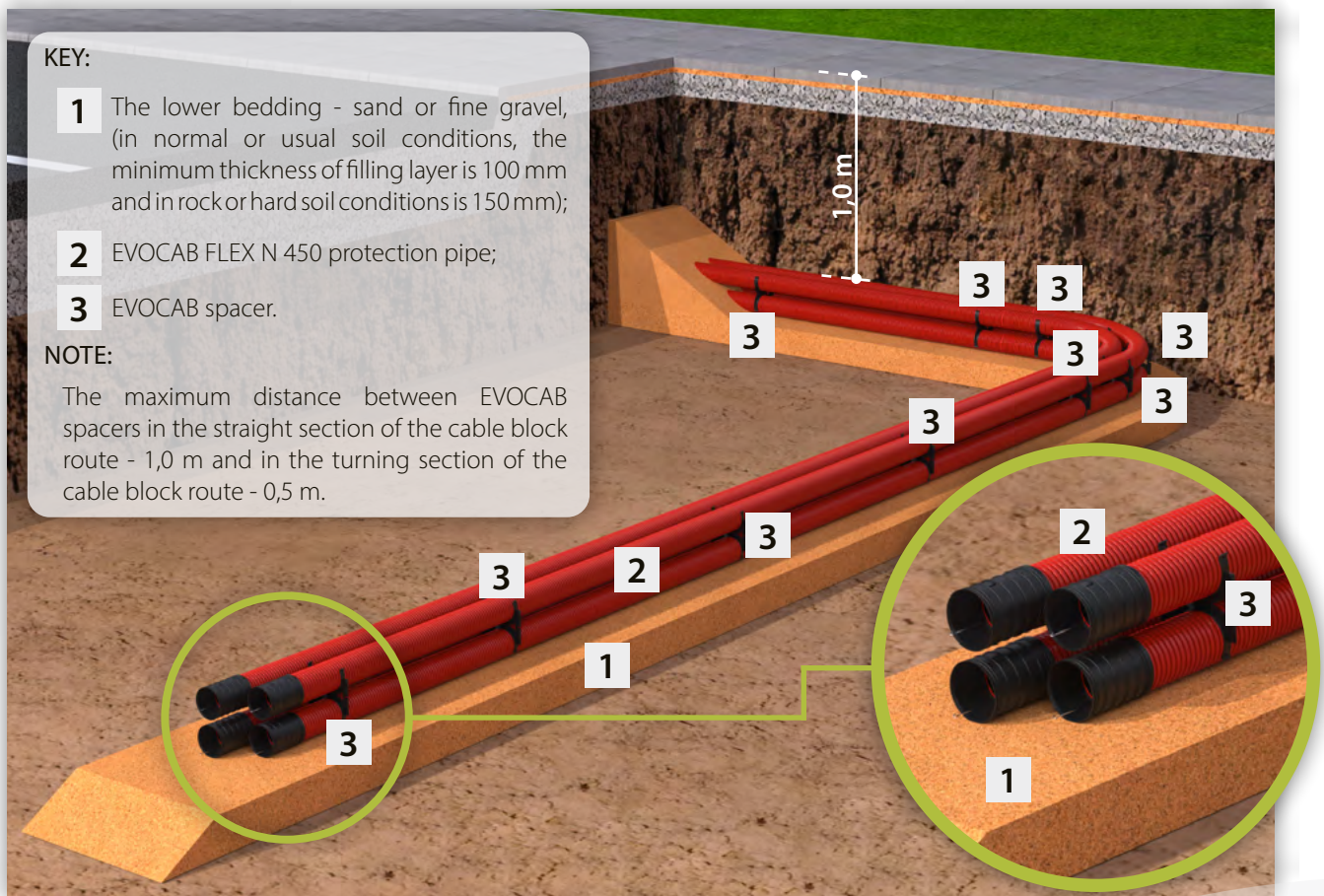

**KEY:**

- 1** The lower bedding - sand or fine gravel, (in normal or usual soil conditions, the minimum thickness of filling layer is 100 mm and in rock or hard soil conditions is 150 mm);
- 2** EVOcab FLEX N 450 protection pipe;
- 3** EVOcab spacer.

**NOTE:**

The maximum distance between EVOcab spacers in the straight section of the cable block route - 1,0 m and in the turning section of the cable block route - 0,5 m.

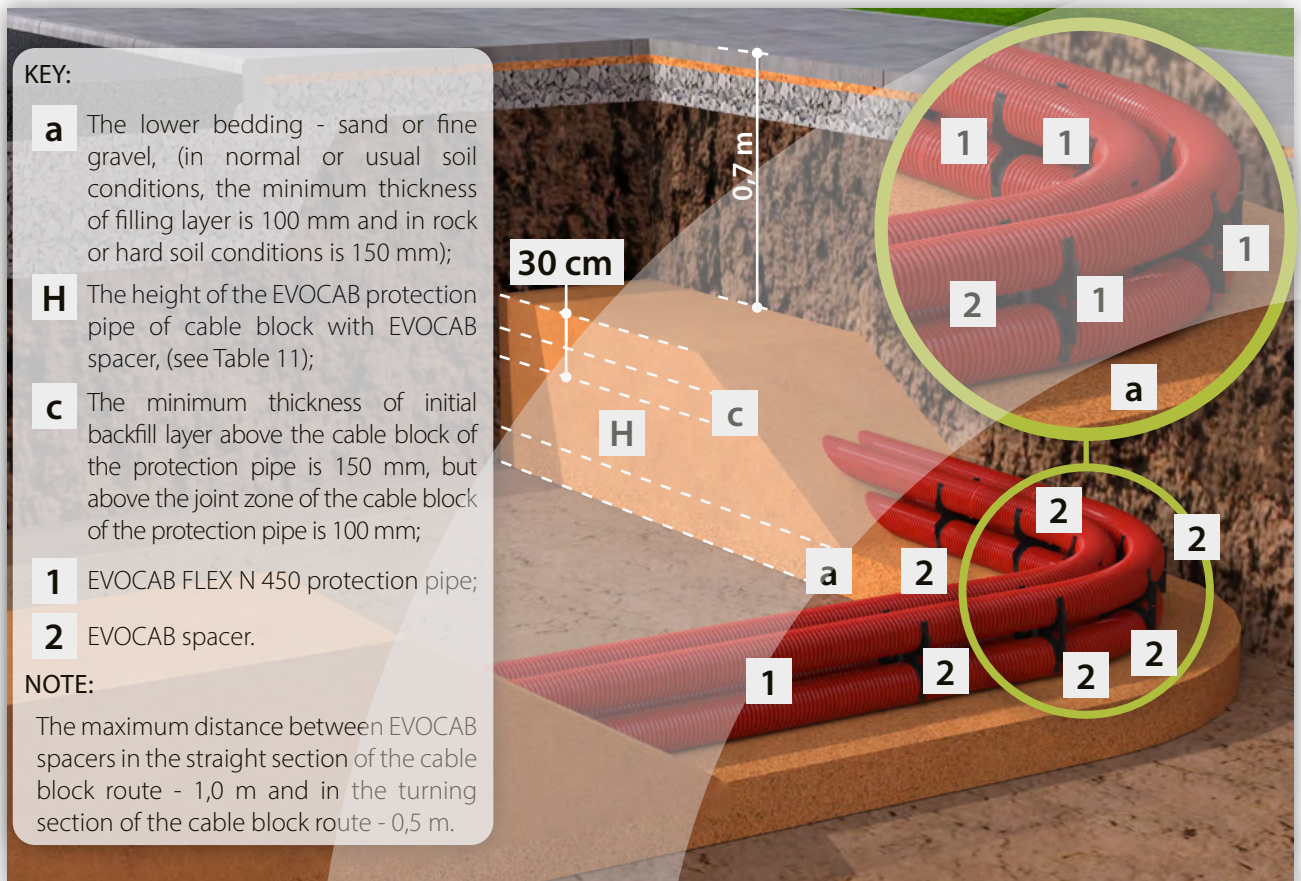

**KEY:**

- a** The lower bedding - sand or fine gravel, (in normal or usual soil conditions, the minimum thickness of filling layer is 100 mm and in rock or hard soil conditions is 150 mm);
- H** The height of the EVOcab protection pipe of cable block with EVOcab spacer, (see Table 11);
- c** The minimum thickness of initial backfill layer above the cable block of the protection pipe is 150 mm, but above the joint zone of the cable block of the protection pipe is 100 mm;
- 1** EVOcab FLEX N 450 protection pipe;
- 2** EVOcab spacer.

**NOTE:**

The maximum distance between EVOcab spacers in the straight section of the cable block route - 1,0 m and in the turning section of the cable block route - 0,5 m.



Example of the installation of a 90° turn of a cable block route with EVOcab HARD N 450 protection pipes, EVOcab ELBOW N 750 and EVOcab spacers

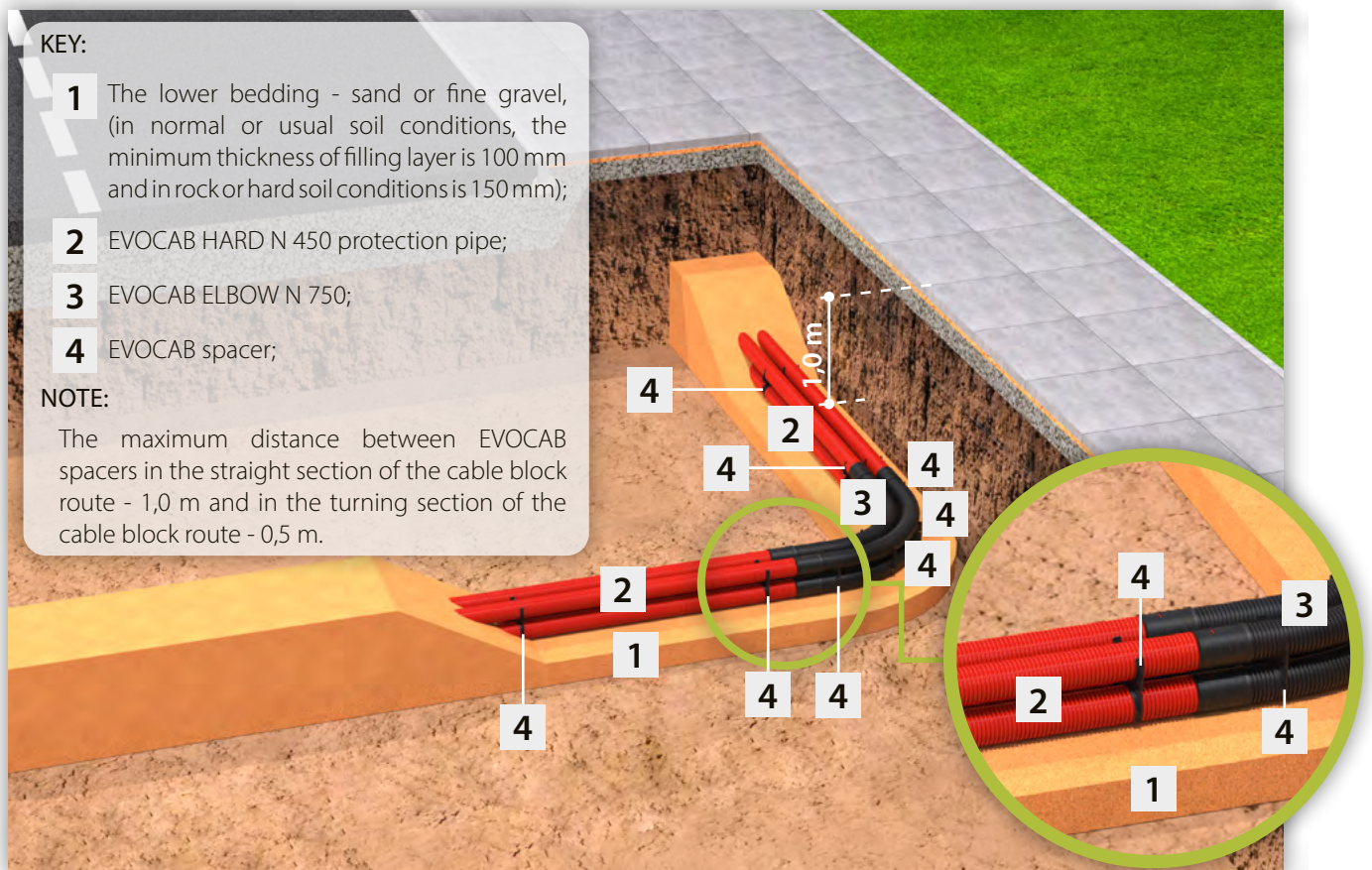
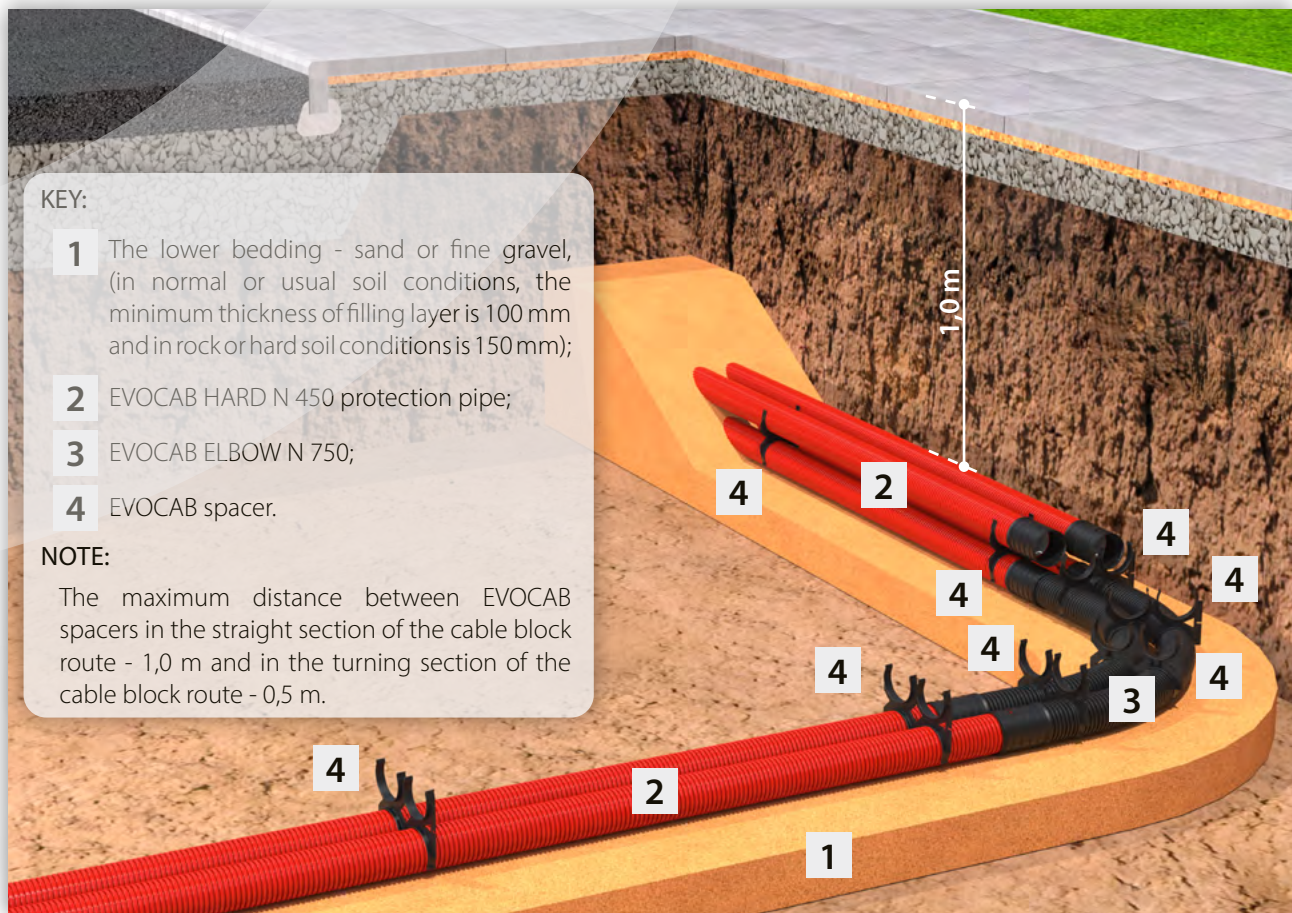



Example of the installation of a 90° and 45° turn of a cable block route with EVOcab HARD N 750 protection pipes, EVOcab ELBOWS N 750 and EVOcab spacers

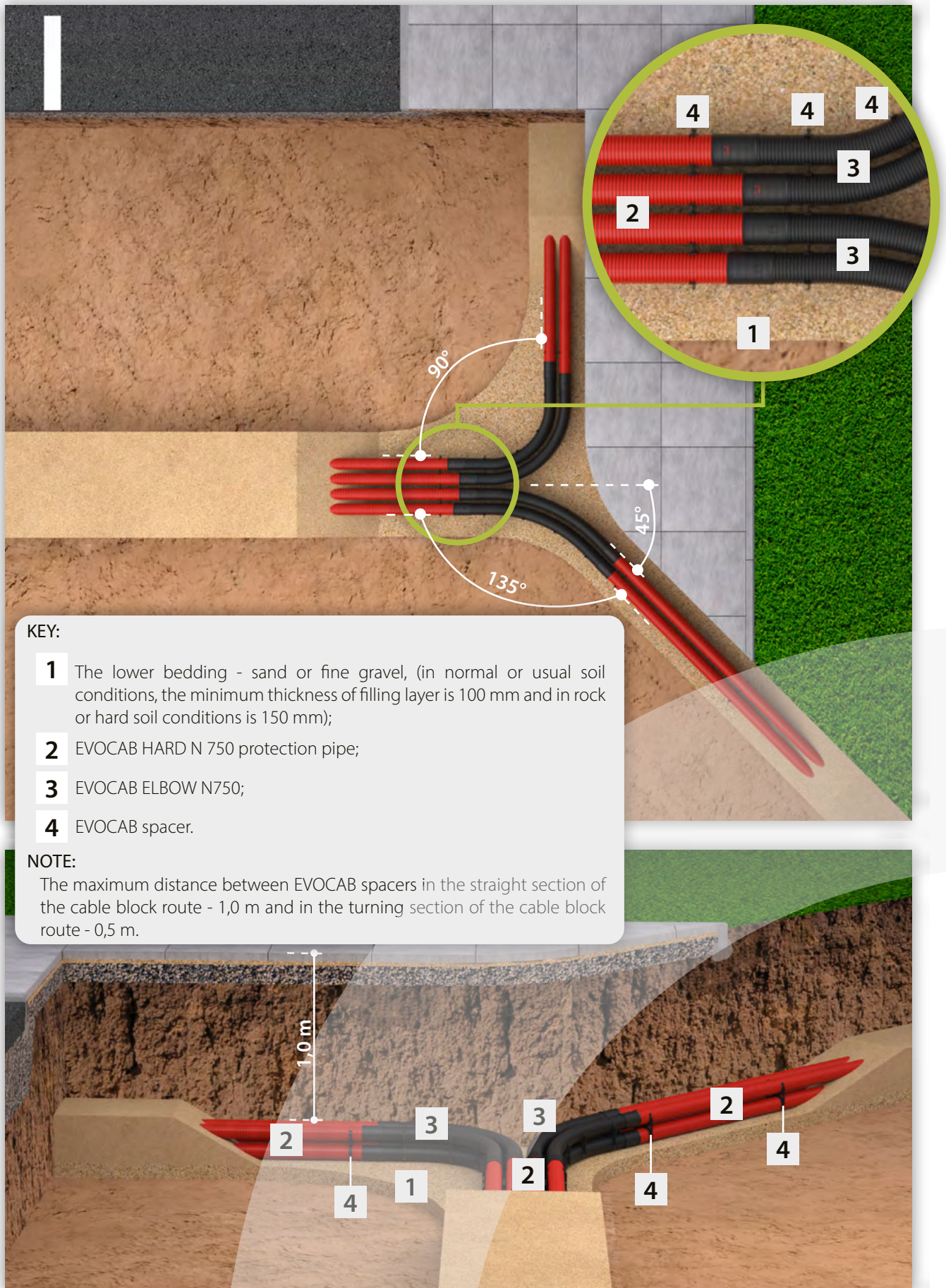

**KEY:**

- 1** The lower bedding - sand or fine gravel, (in normal or usual soil conditions, the minimum thickness of filling layer is 100 mm and in rock or hard soil conditions is 150 mm);
- 2** EVOcab HARD N 750 protection pipe;
- 3** EVOcab ELBOW N750;
- 4** EVOcab spacer.

**NOTE:**

The maximum distance between EVOcab spacers in the straight section of the cable block route - 1,0 m and in the turning section of the cable block route - 0,5 m.

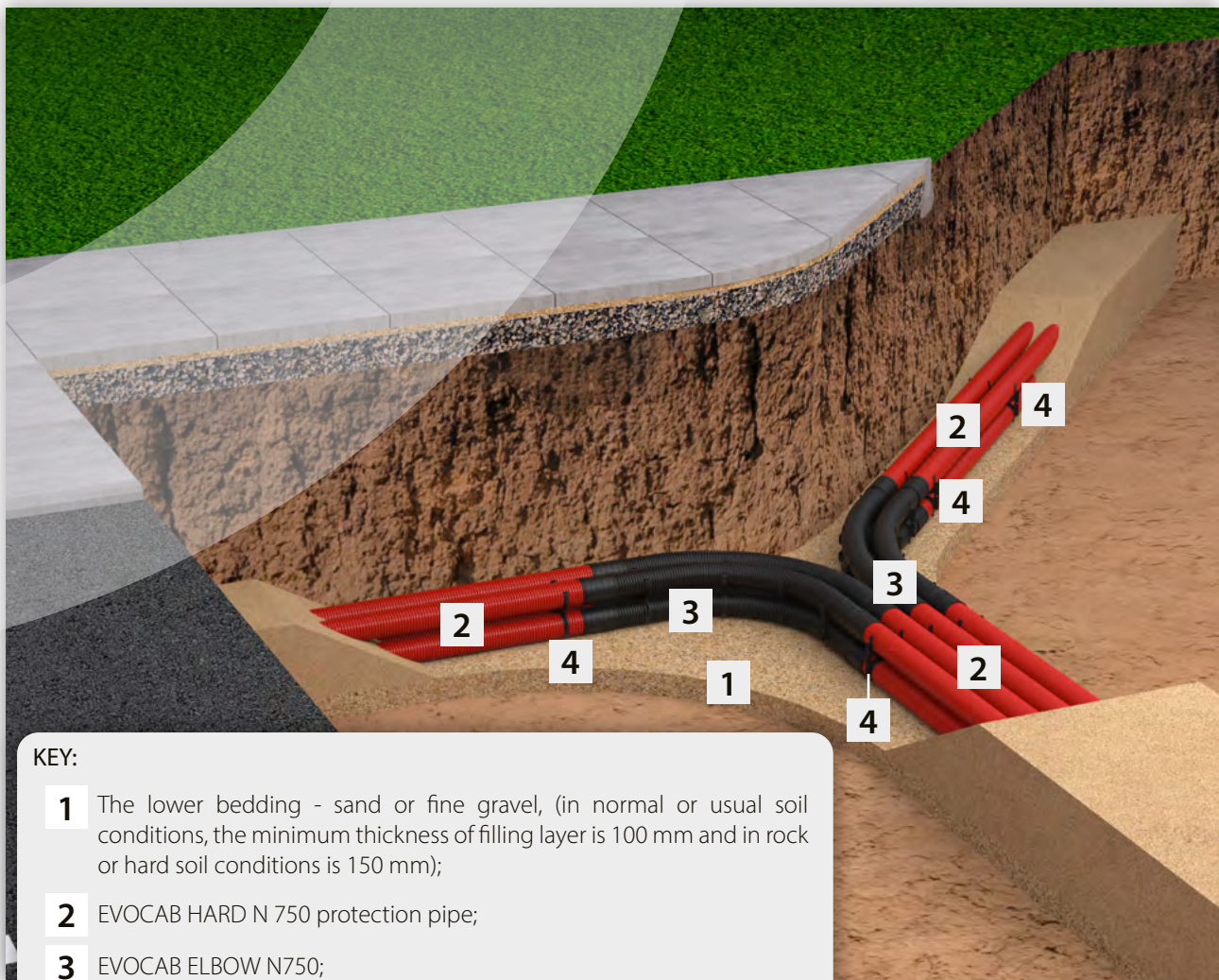

## KEY:

- 1** The lower bedding - sand or fine gravel, (in normal or usual soil conditions, the minimum thickness of filling layer is 100 mm and in rock or hard soil conditions is 150 mm);
- 2** EVOcab HARD N 750 protection pipe;
- 3** EVOcab ELBOW N750;
- 4** EVOcab spacer.

## NOTE:

The maximum distance between EVOcab spacers in the straight section of the cable block route - 1,0 m and in the turning section of the cable block route - 0,5 m.

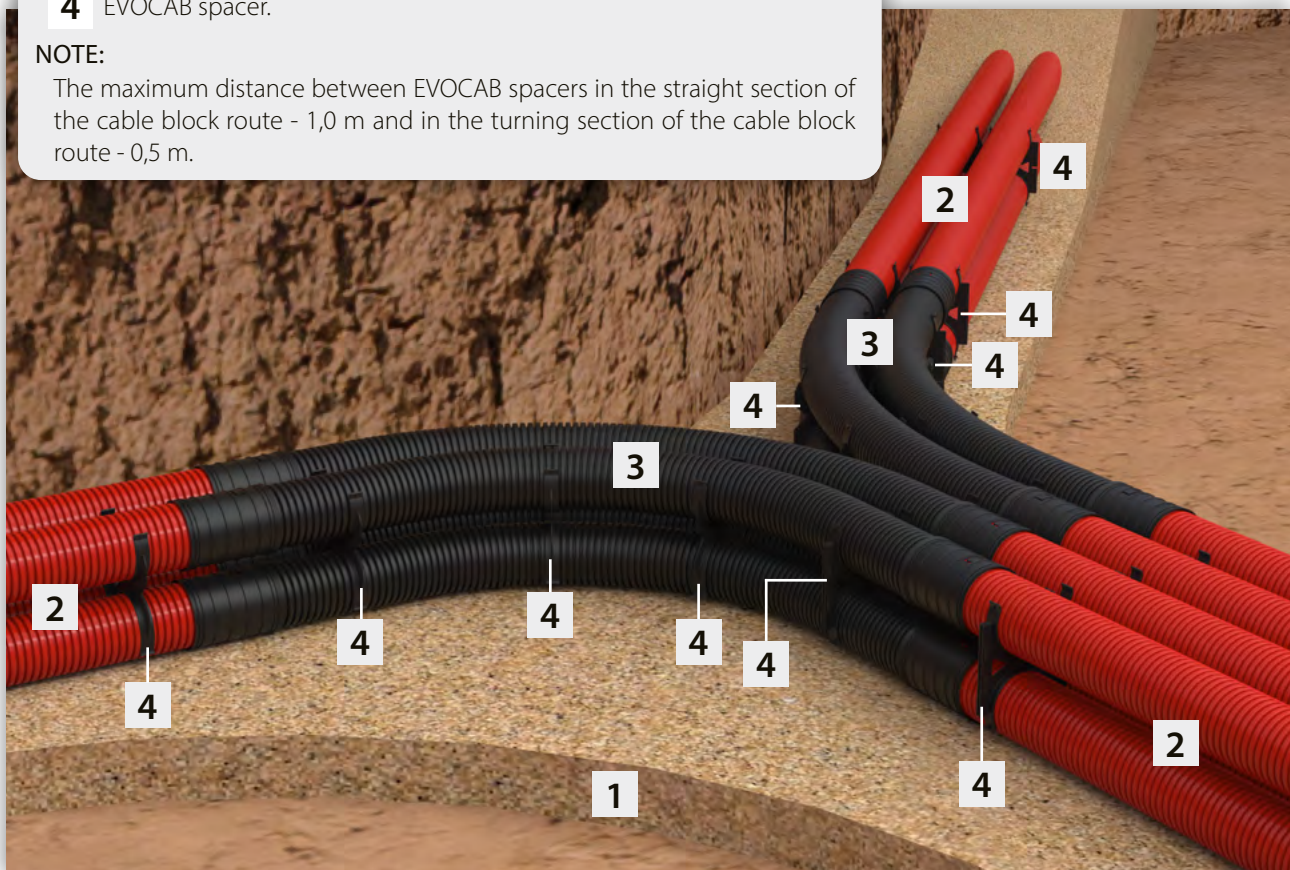





## INSTALLATION OF CABLE BLOCKS

When installing a cable block channels in a trench from protection pipes in several layers, each layer of protection pipes must be installed separately by layers. From the beginning, install the first lower layer of protection pipes, then cover it with soil backfill material and compact it to the appropriate degree of density according to the construction project, and only then install the next layer of protection pipes above the lower layer. Repeat all the above mentioned installation steps with the rest of the protection pipe layers.

Mandatory provide dynamic load dispersion (reduction) measures in the trench on top coat of protection pipes that will occur during operation, for example, by installing them in concrete in high traffic areas **with a minimum covering thickness of filling layer above the protection pipe, which is less than 50 cm**, for example, by making protection pipeline routes backfilling works, use a cement-sand mixture as backfill material for trench filling.

When constructing the protective pipeline route in concrete, before starting the concreting work in the trench, make sure that the protective pipe connections are hermetic (the type of connection with sealing rubbers and hermetic connection sleeves must be used), and that the pipes are secured so that



the pipes do not float when the concrete is poured (they are pushed out from the concrete mass).

During the assembly of the protection pipe blocks, install the EVOCAB spacers in a manner to avoid an unacceptable deflection. Install the EVOCAB spacers every 1,0m (FLEX type) and up to 1,5m (HARD type), but on turns of the sections in the track every 0,5m.

### Installation example of the cable block: in one layer with 4 protection pipes

#### LEGEND:

- 1** Trench filling in the zone around the cable block is compacted with filling soil material, e.g. sand or fine gravel, compaction class W, (see Table 6, Table 7 and Table 8);
- 2** Protection pipe with the filled up cable channel;
- 2R** Protection pipe with recommended spare cable channel;
- 3** EVOCAB (protection pipe) spacer, (see Table 16);

**c** – The minimum thickness of initial backfill layer above the cable block of the protection pipe is 150 mm, but above the joint zone of the cable block of the protection pipe is 100 mm;

**d/2** – EVOCAB (protection pipe) spacer size, (see Table 16);

**H = OD/2 + d/2** – The height of the protection pipe of cable block with EVOCAB spacer, (see Table 16);

**OD** – Protection pipe outside diameter, (see Table 16);

**a** – The minimum thickness of lower bedding filling layer in usual soil conditions is 100 mm and in rock or hard soil conditions is 150 mm;

**C** – EVOCAB (protection pipe) spacer size, (see Table 16);

**L/2** - The minimum working space in the area between the protection pipe of cable block and the trench wall or the support if present, (see Table 4);

**4-protection pipes** – EVOCAB (protection pipe) spacer length, (see Table 16);

**B = 4-protection pipes + (2 x L/2) = 4-protection pipes + L** - Cable block trench width.

#### ATTENTION!

When carrying out soil material compaction basic works in the trench zone above the cable block of protection pipes using heavy compaction technique (>0.60 kN), the following conditions must be observed: in the zone above the protection pipes, there must be ≥30 cm thick top layer of the soil material filling embedment, but in the zone above the protection pipes joints ≥20 cm.

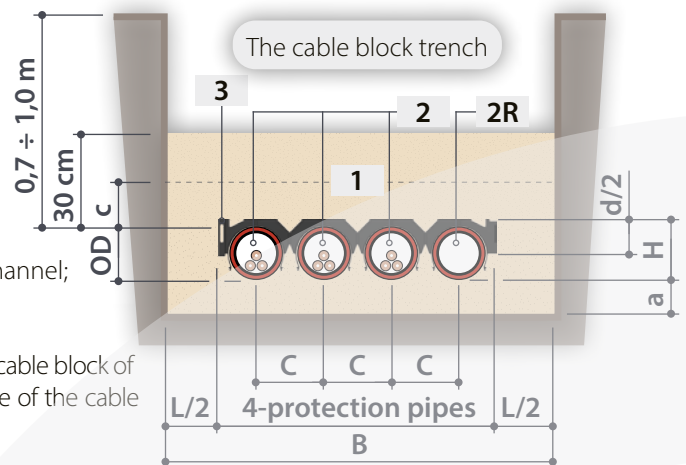



## Installation example of the cable block: in two layer with 8 protection pipes

### LEGEND:

- 1** Trench filling in the zone around the cable block is compacted with filling soil material, e.g. sand or fine gravel, compaction class W, (see Table 6, Table 7 and Table 8);
  - 2** Protection pipe with the filled up cable channel;
  - 2R** Protection pipe with recommended spare cable channel;
  - 3** EVOCAB (protection pipe) spacer, (see Table 13);
- c** – The minimum thickness of initial backfill layer above the cable block of the protection pipe is 150 mm, but above the joint zone of the cable block of the protection pipe is 100 mm;
- d** – EVOCAB (protection pipe) spacer size, (see Table 13);
- H = OD + d** – The height of the protection pipe of cable block with EVOCAB spacer, (see Table 13);
- OD** – Protection pipe outside diameter, (see Table 13);
- a** – The minimum thickness of lower bedding filling layer in usual soil conditions is 100 mm and in rock or hard soil conditions is 150 mm;
- C** – EVOCAB (protection pipe) spacer size, (see Table 13);
- L/2** - The minimum working space in the area between the protection pipe of cable block and the trench wall or the support if present, (see Table 4);
- 8-protection pipes** – EVOCAB (protection pipe) spacer length, (see Table 13);
- B = 8-protection pipes + (2 x L/2) = 8-protection pipes + L** - Cable block trench width.

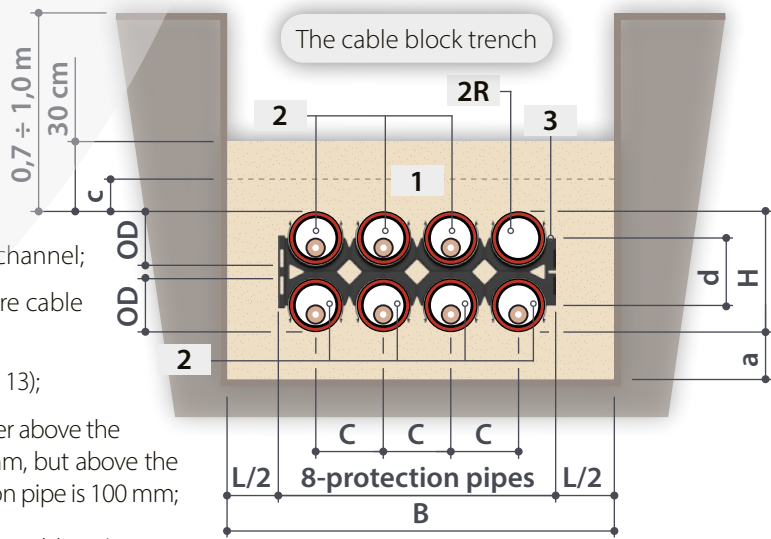

### ATTENTION!

When carrying out soil material compaction works in the trench zone above the cable block of protection pipes using heavy compaction technique (>0.60 kN), the following conditions must be observed: in the zone above the protection pipes, there must be ≥30 cm thick a top layer of the soil material filling embedment, but in the zone above the protection pipes joints ≥20 cm.





Installation example of the cable block: in three layer with 12 protection pipes

LEGEND:

- 1** Trench filling in the zone around the cable block is compacted with filling soil material, e.g. sand or fine gravel, compaction class W, (see Table 6, Table 7 and Table 8);
- 2** Protection pipe with the filled up cable channel;
- 2R** Protection pipe with recommended spare cable channel;
- 3** EVOCAB (protection pipe) spacer, quantity - 2 pcs., (see Table 13);

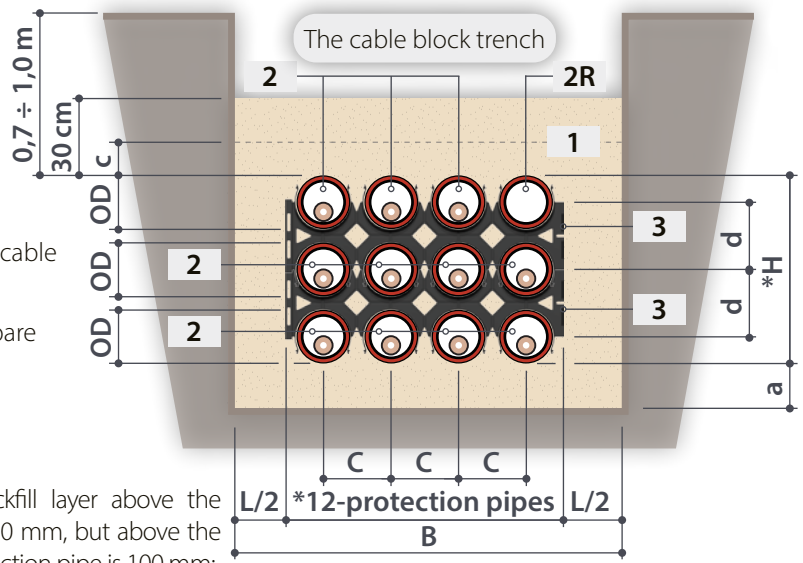

**c** – The minimum thickness of initial backfill layer above the cable block of the protection pipe is 150 mm, but above the joint zone of the cable block of the protection pipe is 100 mm;

**d** – EVOCAB (protection pipe) spacer size, (see Table13);

**\*H = OD + d + d = OD + 2 x d** – The height of the protection pipe cable block;

**OD** – Protection pipe outside diameter, (see Table 13);

**a** – The minimum thickness of lower bedding filling layer in usual soil conditions is 100 mm and in rock or hard soil conditions is 150 mm;

**C** – EVOCAB (protection pipe) spacer size, (see Table 13);

**L/2** - The minimum working space in the area between the protection pipe of cable block and the trench wall or the support if present, (see Table 4);

**\*12-protection pipes = 8-protection pipes** – EVOCAB (protection pipe) spacer length, (see Table 13);

**B = 8-protection pipes + (2 x L/2) = 8-protection pipes + L** - Cable block trench width;

**\*** - Considering that the cable block is install in 3 height levels, EVOCAB spacers are used for its build, which are designed for 8-protection pipes, because they are assembled with each other in the 2 height levels of the cable block with the protection pipe, see the joint installation illustration on page 28, under the heading an **Example of assembly of EVOCAB spacers in a cable block of 12-protection pipes in 3 height levels.**

ATTENTION!

When carrying out soil material compaction works in the trench zone above the cable block of protection pipes using heavy compaction technique (>0.60 kN), the following conditions must be observed: in the zone above the protection pipes, there must be ≥30 cm thick top layer of the soil material filling embedment, but in the zone above the protection pipes joints ≥20 cm.





An example of an illustration of the installation of a cable block in the green area at a depth of 1,0 m from the ground surface

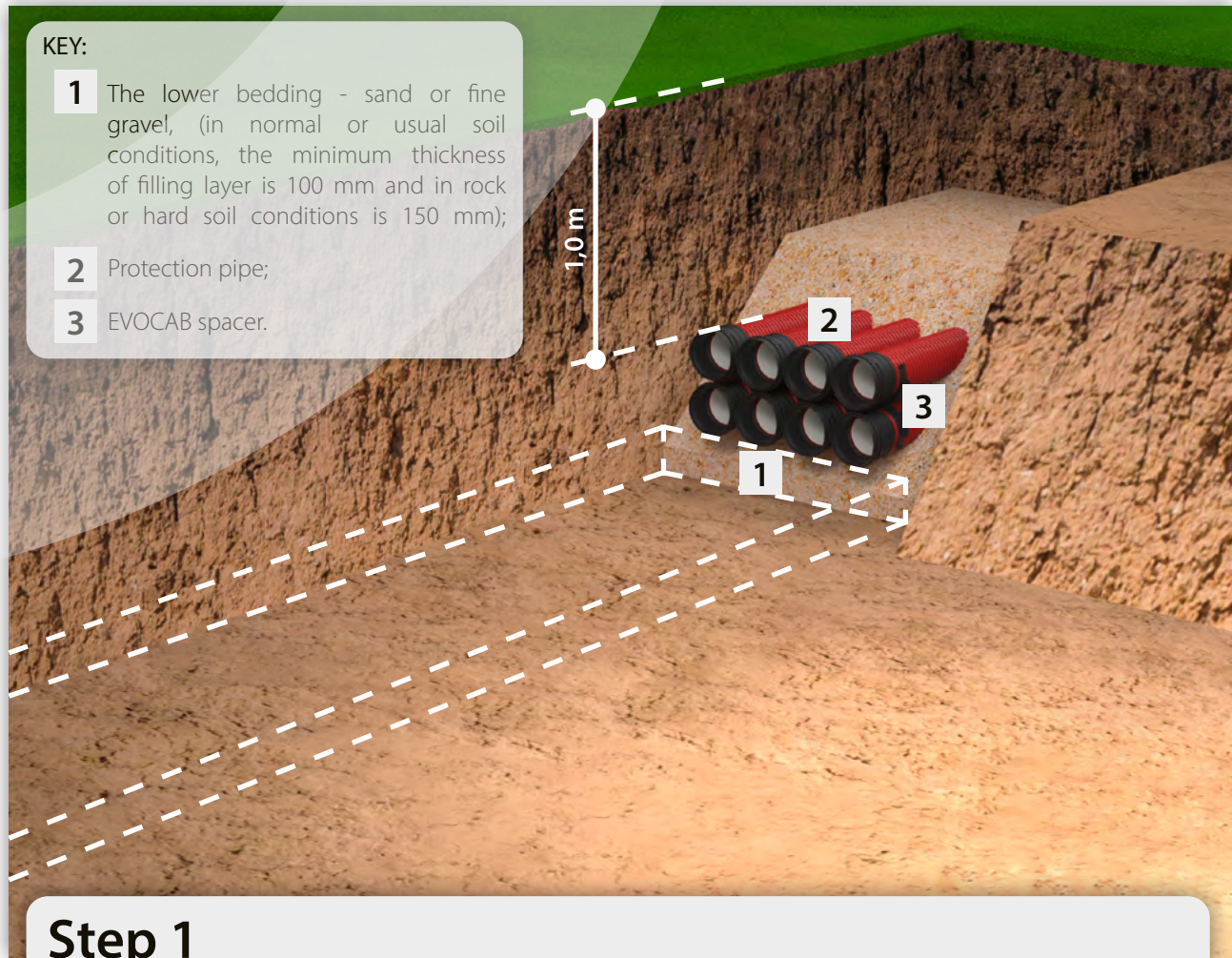

KEY:

- 1 The lower bedding - sand or fine gravel, (in normal or usual soil conditions, the minimum thickness of filling layer is 100 mm and in rock or hard soil conditions is 150 mm);
- 2 Protection pipe;
- 3 EVOCAB spacer.

## Step 1

In the trench, the thickness of lower bedding filling layer is installed, which is compacted to the required degree of density according to the project.

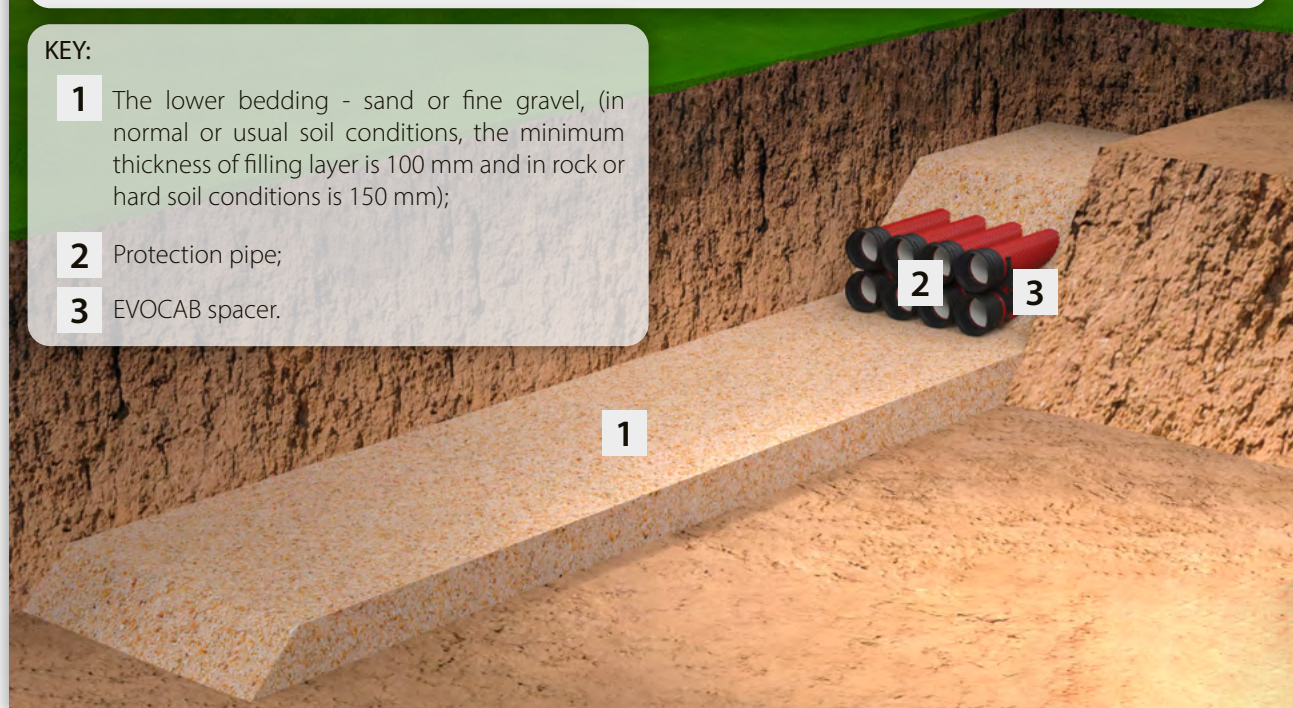

KEY:

- 1 The lower bedding - sand or fine gravel, (in normal or usual soil conditions, the minimum thickness of filling layer is 100 mm and in rock or hard soil conditions is 150 mm);
- 2 Protection pipe;
- 3 EVOCAB spacer.



## Step 2

The first layer of the cable block is installed from the protection pipes on the lower bedding of the filling layer.

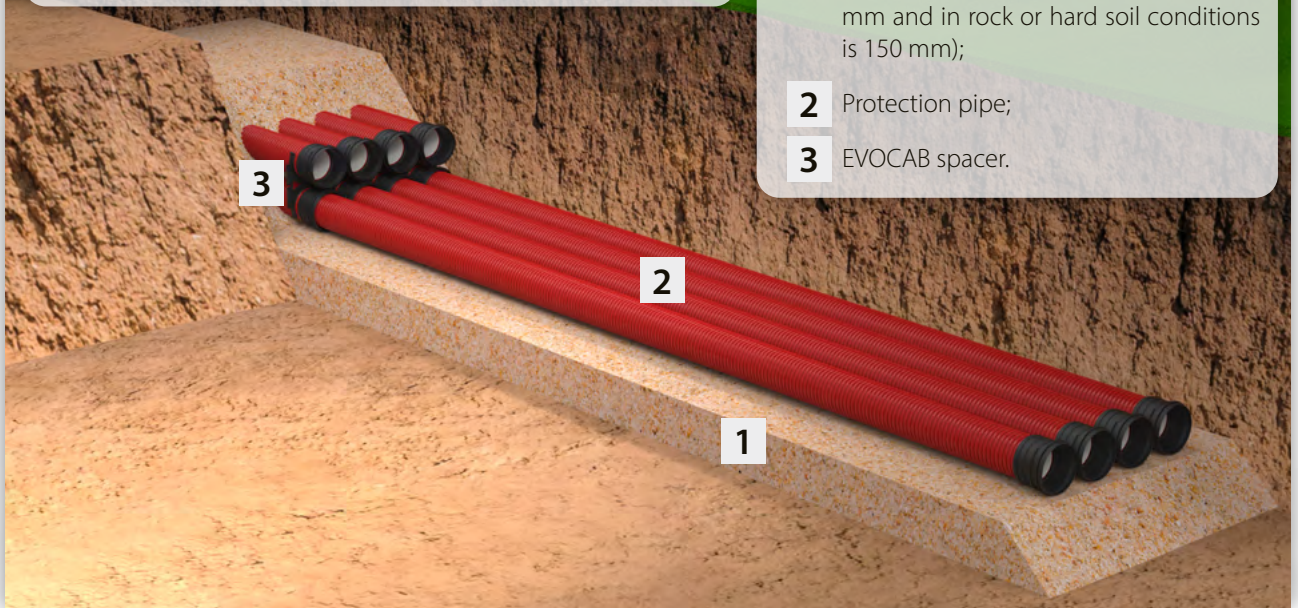

**KEY:**

- 1** The lower bedding - sand or fine gravel, (in normal or usual soil conditions, the minimum thickness of filling layer is 100 mm and in rock or hard soil conditions is 150 mm);
- 2** Protection pipe;
- 3** EVOcab spacer.

## Step 3

Assembly of EVOcab spacers is carried out on the protection pipes of the first layer of the cable block.

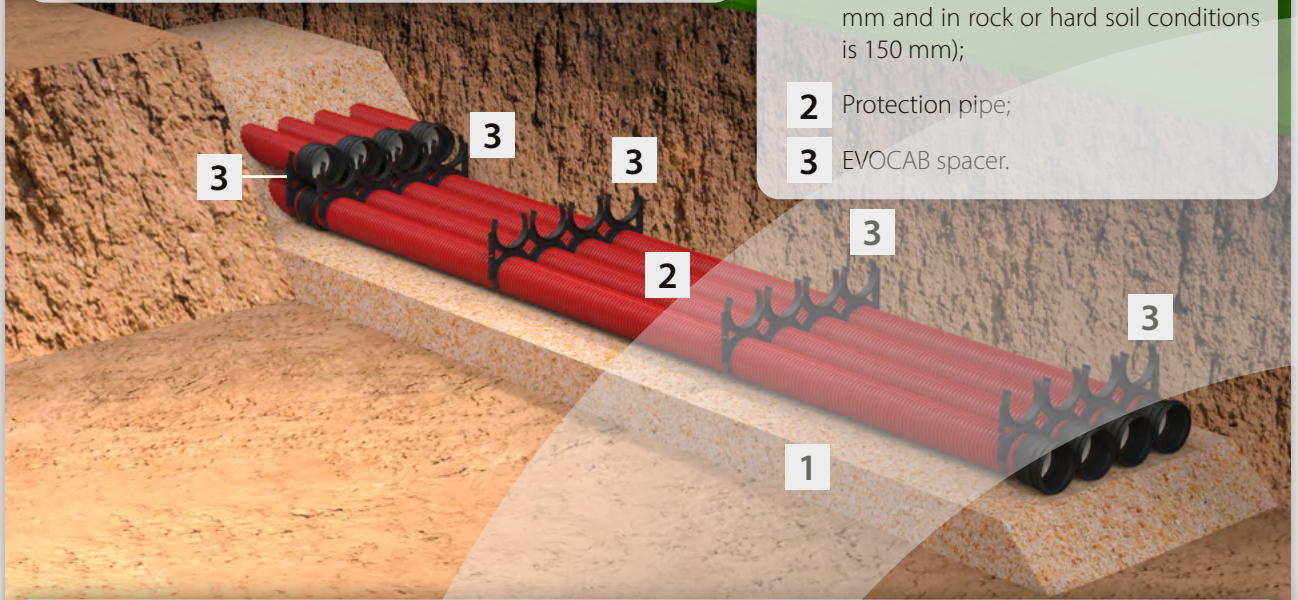

**KEY:**

- 1** The lower bedding - sand or fine gravel, (in normal or usual soil conditions, the minimum thickness of filling layer is 100 mm and in rock or hard soil conditions is 150 mm);
- 2** Protection pipe;
- 3** EVOcab spacer.

**NOTE:**

The recommended maximum placement distance between EVOcab spacers in a straight section of the cable block route:

- ▶ EVOcab FLEX N 450 - 1,0 m;
- ▶ EVOcab HARD N 450, EVOcab HARD N 750, RIGID MULTI PP N 750 and EVOcab SUPERHARD N 1250 - 1,5 m.

Recommended maximum placement distance between EVOcab spacers in the turning sections of the cable block route:

- ▶ EVOcab FLEX N 450, EVOcab FLEX FR UV 0H, EVOcab ELBOW N 450 and EVOcab FLEX N 750 - 0,5 m.



## Step 4

When the assembly of the EVOcab spacers on the first layer of protection pipes of the cable block is completed, backfill the first layer protection pipes of the cable block with soil filling material, e.g. sand or fine gravel.

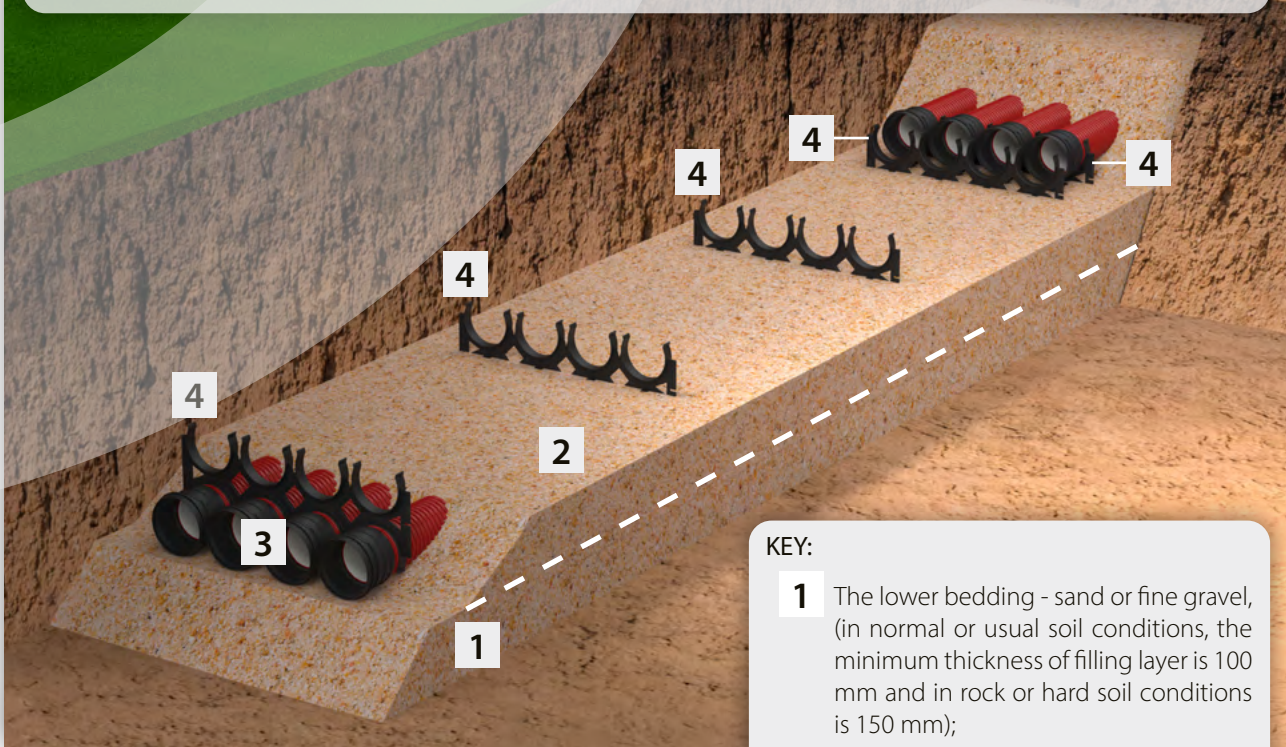

### KEY:

- 1** The lower bedding - sand or fine gravel, (in normal or usual soil conditions, the minimum thickness of filling layer is 100 mm and in rock or hard soil conditions is 150 mm);
- 2** Backfilling of the protection pipes of the first layer of the cable block with soil filling material, e.g. sand or fine gravel;
- 3** Protection pipe;
- 4** EVOcab spacer.

## Step 5

Carry out the assembly of the second layer of protection pipes of the cable block in the EVOcab spacers.

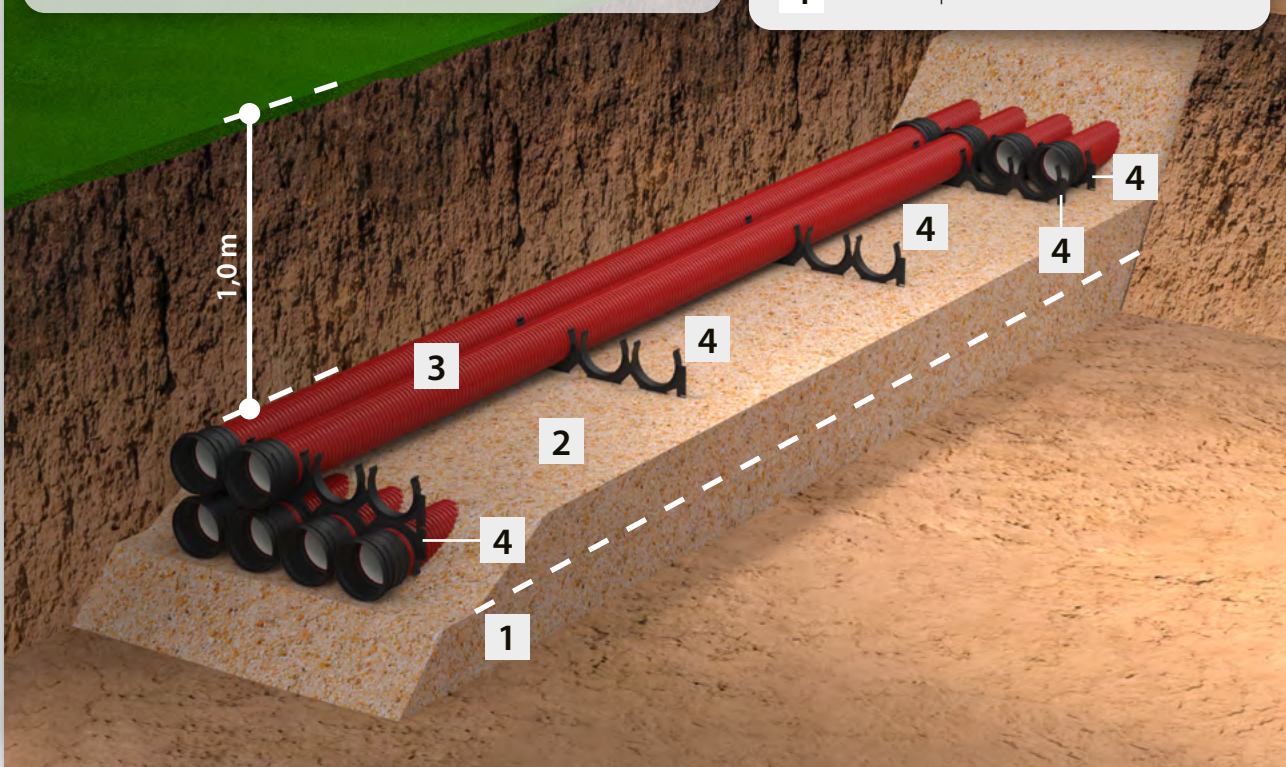

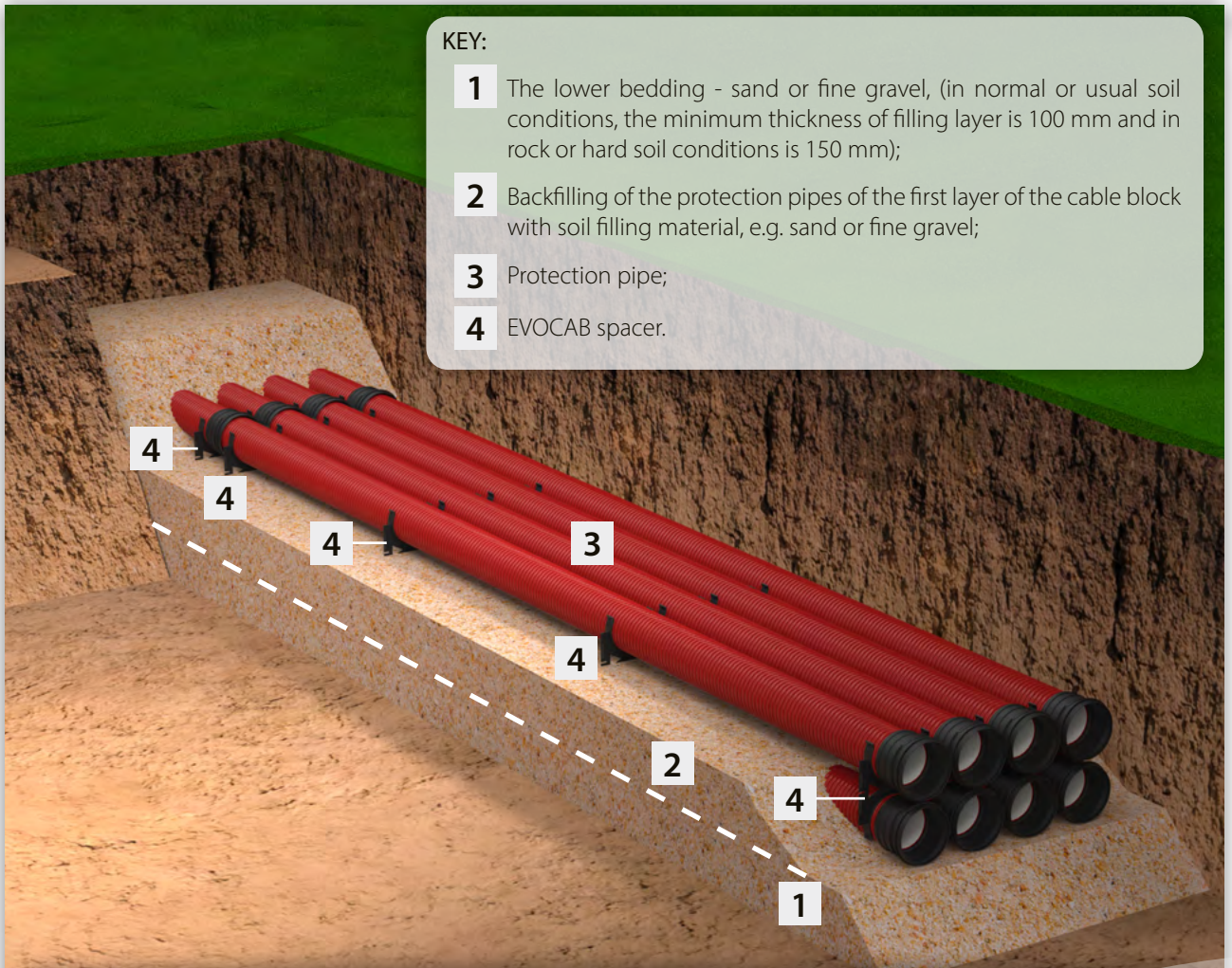

KEY:

- 1** The lower bedding - sand or fine gravel, (in normal or usual soil conditions, the minimum thickness of filling layer is 100 mm and in rock or hard soil conditions is 150 mm);
- 2** Backfilling of the protection pipes of the first layer of the cable block with soil filling material, e.g. sand or fine gravel;
- 3** Protection pipe;
- 4** EVOCAB spacer.

## Step 6

When the assembly of the second layer of protection pipes of the cable block is completed, backfilling of the second layer of protection pipes of the cable block is carried out with soil filling material, e.g. sand or fine gravel.

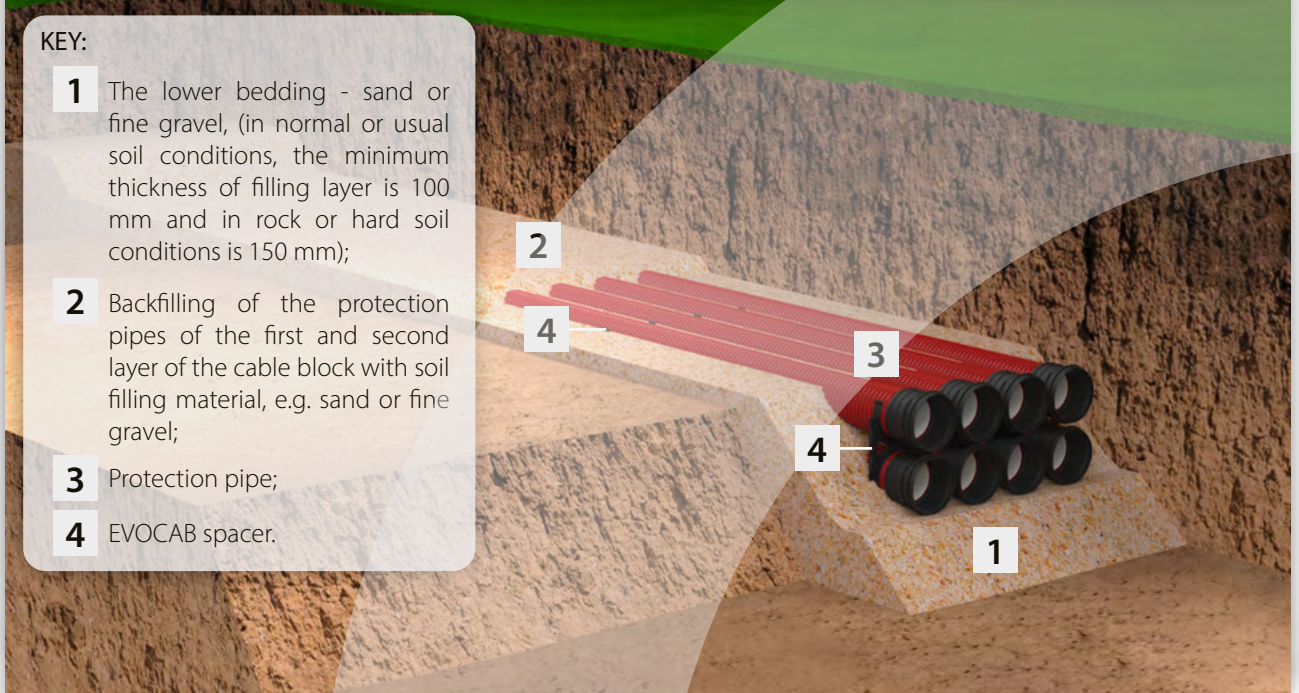

KEY:

- 1** The lower bedding - sand or fine gravel, (in normal or usual soil conditions, the minimum thickness of filling layer is 100 mm and in rock or hard soil conditions is 150 mm);
- 2** Backfilling of the protection pipes of the first and second layer of the cable block with soil filling material, e.g. sand or fine gravel;
- 3** Protection pipe;
- 4** EVOCAB spacer.



## Step 7

When the backfilling of the protection pipes of the second layer of the cable block with soil filling material, e.g. sand or fine gravel, is performed, the installation of initial filling layer above the cable block of protection pipes can be started. When this is done, the trench backfilling works can continue with soil filling material. When the height of the layer of filling material above the cable block of protection pipes has reached 30 cm, compaction of the soil filling material can be performed in the zone above the cable block of protection pipes.

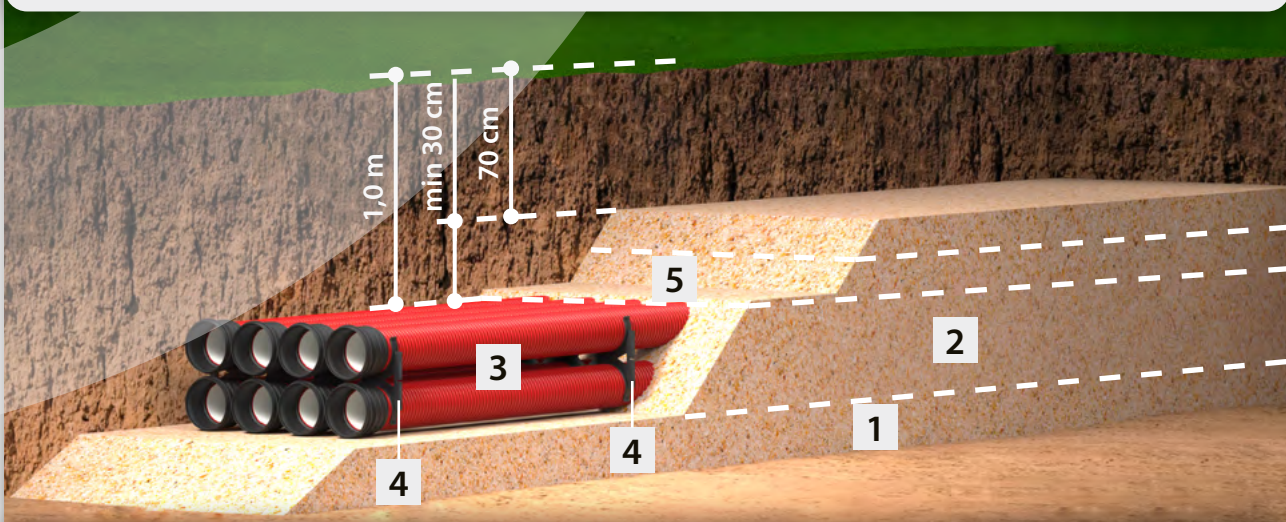

### KEY:

- 1** The lower bedding - sand or fine gravel, (in normal or usual soil conditions, the minimum thickness of filling layer is 100 mm and in rock or hard soil conditions is 150 mm);
- 2** Backfilling of the protection pipes of the first layer of the cable block with soil filling material, e.g. sand or fine gravel;
- 3** Protection pipe;
- 4** EVOCAB spacer;
- 5** The thickness of initial backfill layer, the minimum thickness of initial backfill layer above the cable block of the protection pipe is 150 mm, but above the joint zone of the cable block of the protection pipe is 100 mm;

### ATTENTION!

When carrying out soil material compaction basic works in the trench zone above the cable block of protection pipes using heavy compaction technique ( $>0.60$  kN), the following conditions must be observed: in the zone above the protection pipes, there must be  $\geq 30$  cm thick a top layer of the soil material filling embedment, but in the zone above the protection pipes joints  $\geq 20$  cm.

### NOTE:

The recommended maximum placement distance between EVOCAB spacers in a straight section of the cable block route:

- ▶ EVOCAB FLEX N 450 - 1,0 m;
- ▶ EVOCAB HARD N 450, EVOCAB HARD N 750, RIGID MULTI PP N 750 and EVOCAB SUPERHARD N 1250 - 1,5 m.

Recommended maximum placement distance between EVOCAB spacers in the turning sections of the cable block route:

- ▶ EVOCAB FLEX N 450, EVOCAB FLEX FR UV 0H, EVOCAB ELBOW N 450 and EVOCAB FLEX N 750 - 0,5 m.





## INSTALLATION OF CABLE BLOCKS CLOSE TO THE GROUND SURFACE IN HIGH TRAFFIC LOAD AREA / CONDITIONS

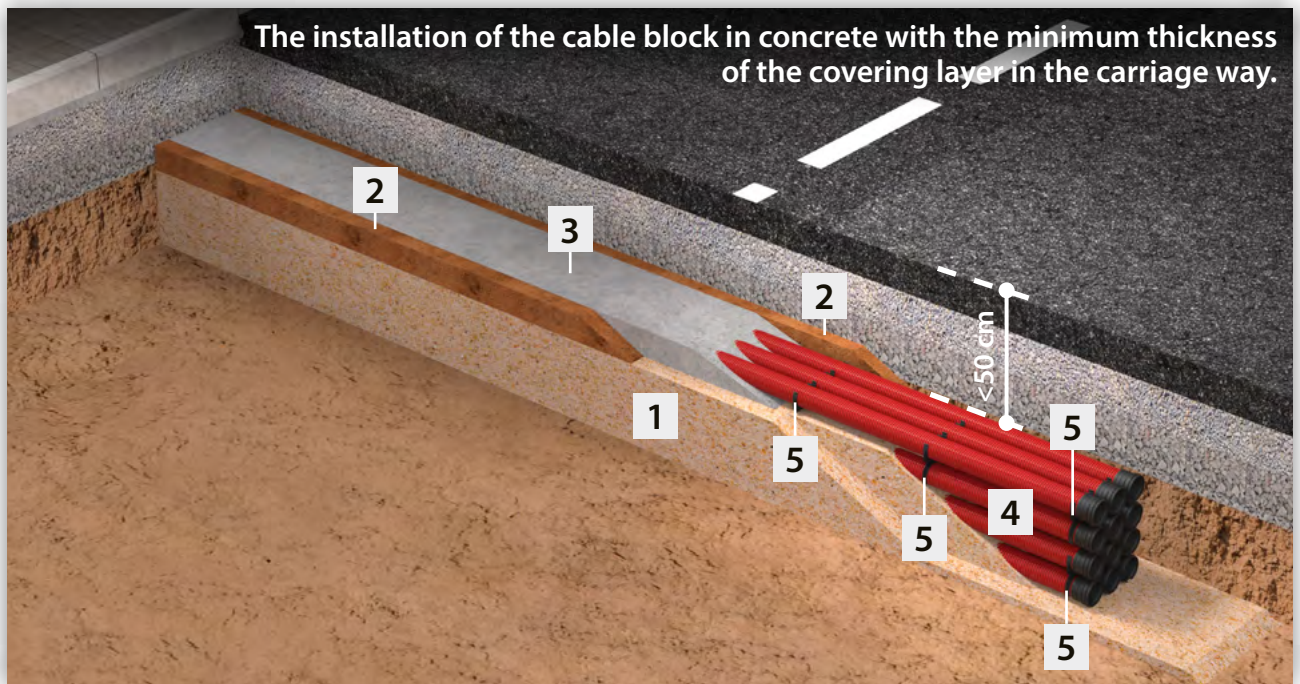

### LEGEND:

- 1** Trench filling in the zone around the cable block compacted with filling soil material, e.g. sand or fine gravel, compaction class W, (see Table 6, Table 7 and Table 8);
- 2** In the zone of the top cable block of the trench, along the wall of the trench and its sides, compacted backfill soil filling material, compaction class W, (see Table 6, table 7 and Table 8);
- 3** In the top zone of the cable block, above the protection pipes, the load distributing concreting, concrete B15;
- 4** Protection pipe with the filled up cable channel;
- 4R** Protection pipe with recommended spare cable channel;
- 5** EVOCAB (protection pipe) spacer, (see Table 12);

**d** – EVOCAB (protection pipe) spacer size, (see Table 12);

**\*H = OD + d** – The height of the protection pipe cable block;

**OD** – Protection pipe outside diameter, (see Table 12);

**a** – The minimum thickness of lower bedding filling layer in usual soil conditions is 100 mm and in rock or hard soil conditions is 150 mm;

**C** – EVOCAB (protection pipe) spacer size, (see Table 12);

**L/2** - The minimum working space in the area between the protection pipe of cable block and the trench wall or the support if present, (see Table 4);;

**\*12-protection pipes = 6-protection pipes – EVOCAB (protection pipe) spacer length, (see Table 12);**

**B = 6-protection pipes + (2 x L/2) = 6-protection pipes + L** - Cable block trench width;

**\*** - Considering that two cable blocks are installed on top of each other at different height levels, EVOCAB spacers designed for 6-protection pipes are used for its built, (see Table 12).

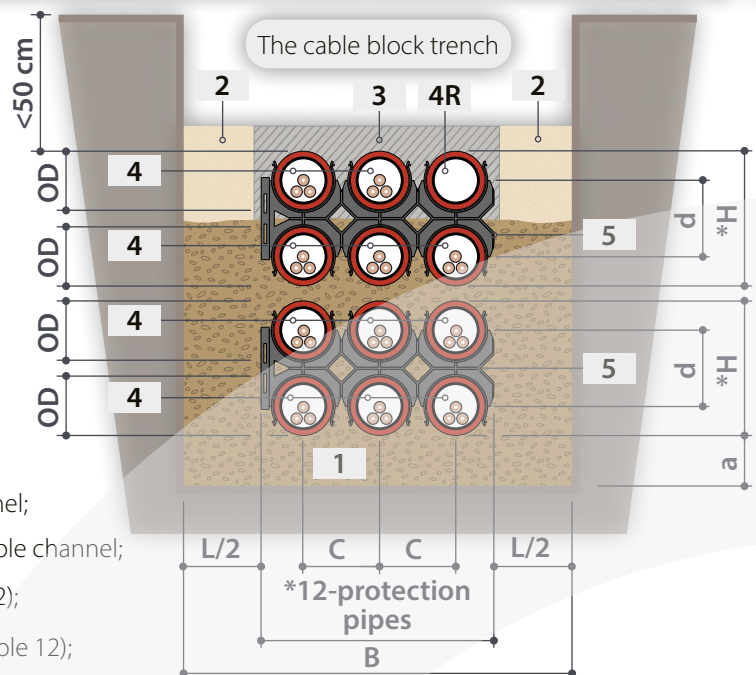



The installation of the cable block in concrete below the minimum allowable cover layer thickness in the carriage way.

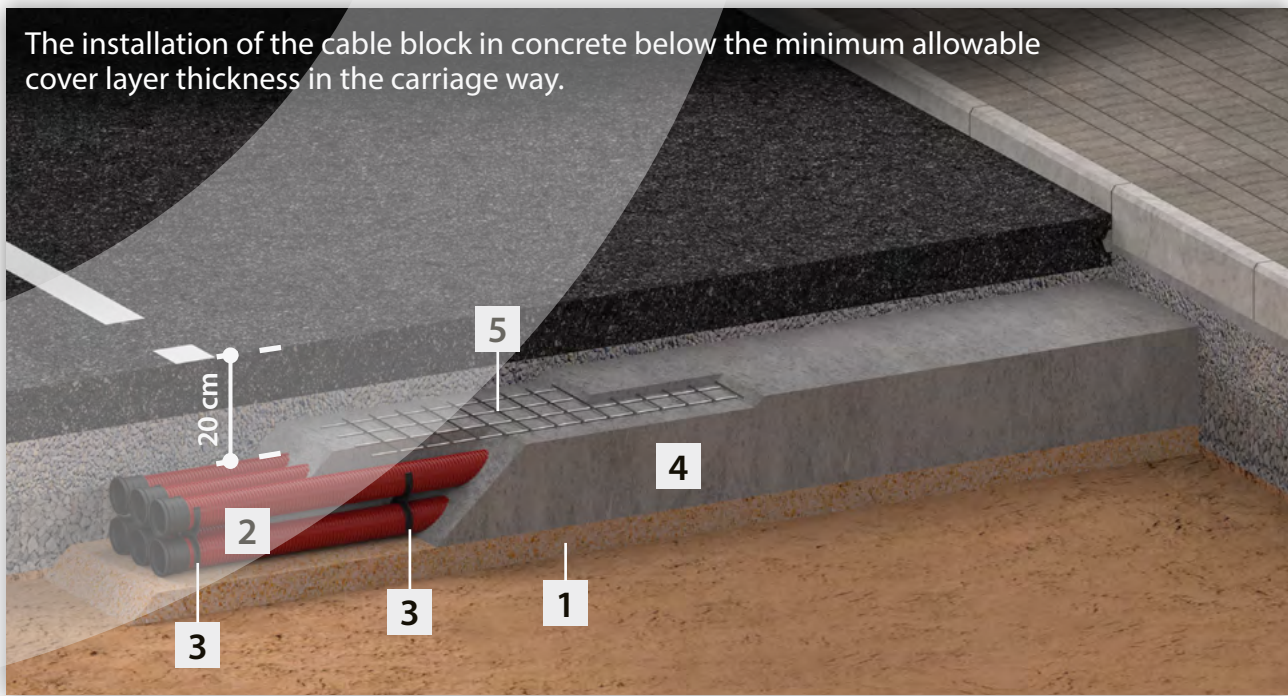

Protection of cable pipes against the bending and mechanical damage in the cable block, which occurs as a result of dynamic loads, if the cable block is built below the minimum permissible cover layer thickness

## LEGEND:

- 1** A compacted layer of filling soil material of the lower bedding of the trench, e.g. sand, compaction class W, (see Table 6, Table 7 and Table 8);
- 2** Protection pipe with the filled up cable channel;
- 2R** Protection pipe with recommended spare cable channel;
- 3** EVOCAB (protection pipe) spacer, (see Table 12);
- 4** Concreted cable block, concrete B15;
- 5** Steel sieve - used to reinforce concreted cable block to increase the dynamic load carrying capacity in the zone above the cable block of protection pipes.

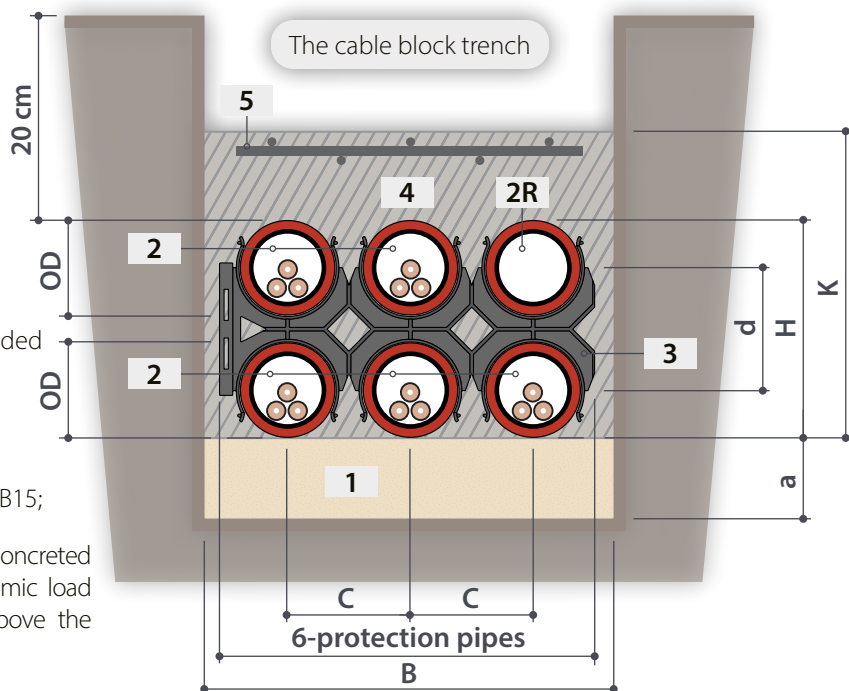

**d** – EVOCAB (protection pipe) spacer size, (see Table 12);

**K** - Concrete cable block length;

**H = OD + d** – The height of the protection pipe of cable block with EVOCAB spacer, (see Table 12);

**OD** – Protection pipe outside diameter, (see Table 12);

**a** – The minimum thickness of lower bedding filling layer in usual soil conditions is 100 mm and in rock or hard soil conditions is 150 mm;

**C** – EVOCAB (protection pipe) spacer size, (see Table 12);

**6-protection pipes** – EVOCAB (protection pipe) spacer length, (see Table 12);

**B** - Cable block trench width (concrete cable block width);



The guidelines for the installation of cable protection pipes are prepared in accordance with EN 61386-1 and EN 61386-24 product standard requirements and binding standards for the construction process EN 805, EN 1610 and CEN/TS 1047.

## TRANSPORTATION AND STORAGE OF PROTECTION PIPES AND THEIR ACCESSORIES

Avoid rapid removal, overturning of the product packaging, as well as strong impacts that can be caused by careless handling during their transportation or storage.

Before the installation, check the protection pipes and their accessories for any defects that may have occurred due to careless storage or transportation.

### Carry out storage at the construction site on a flat surface!

When creating a storage ridge, do not stack the protection pipes one above the other with more than 4 packages. When storing packages on top of each other, the package frames must rest on each other so that the frames provide a support function.

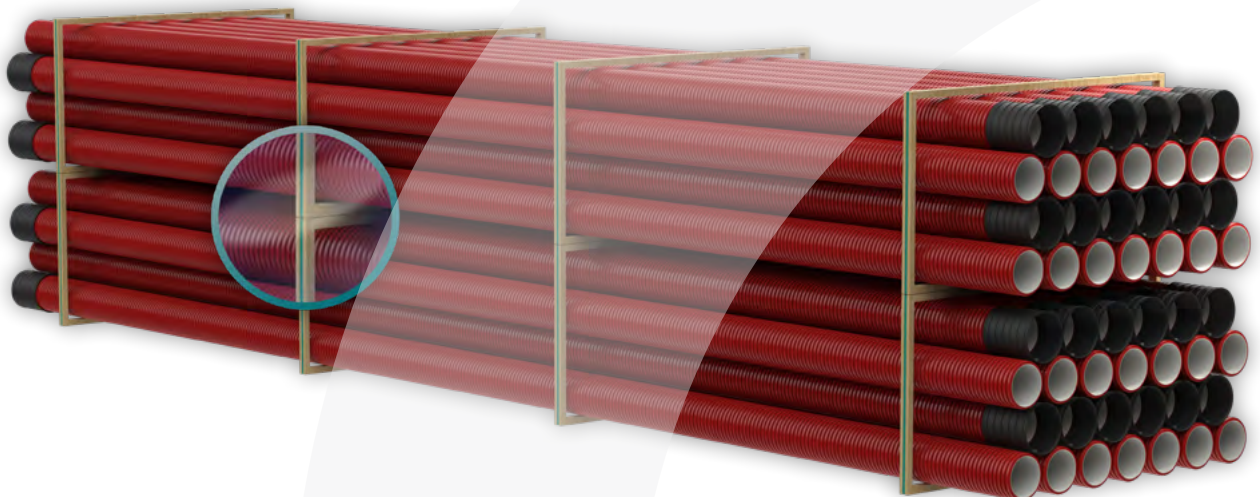



CABLE PROTECTION SYSTEMS

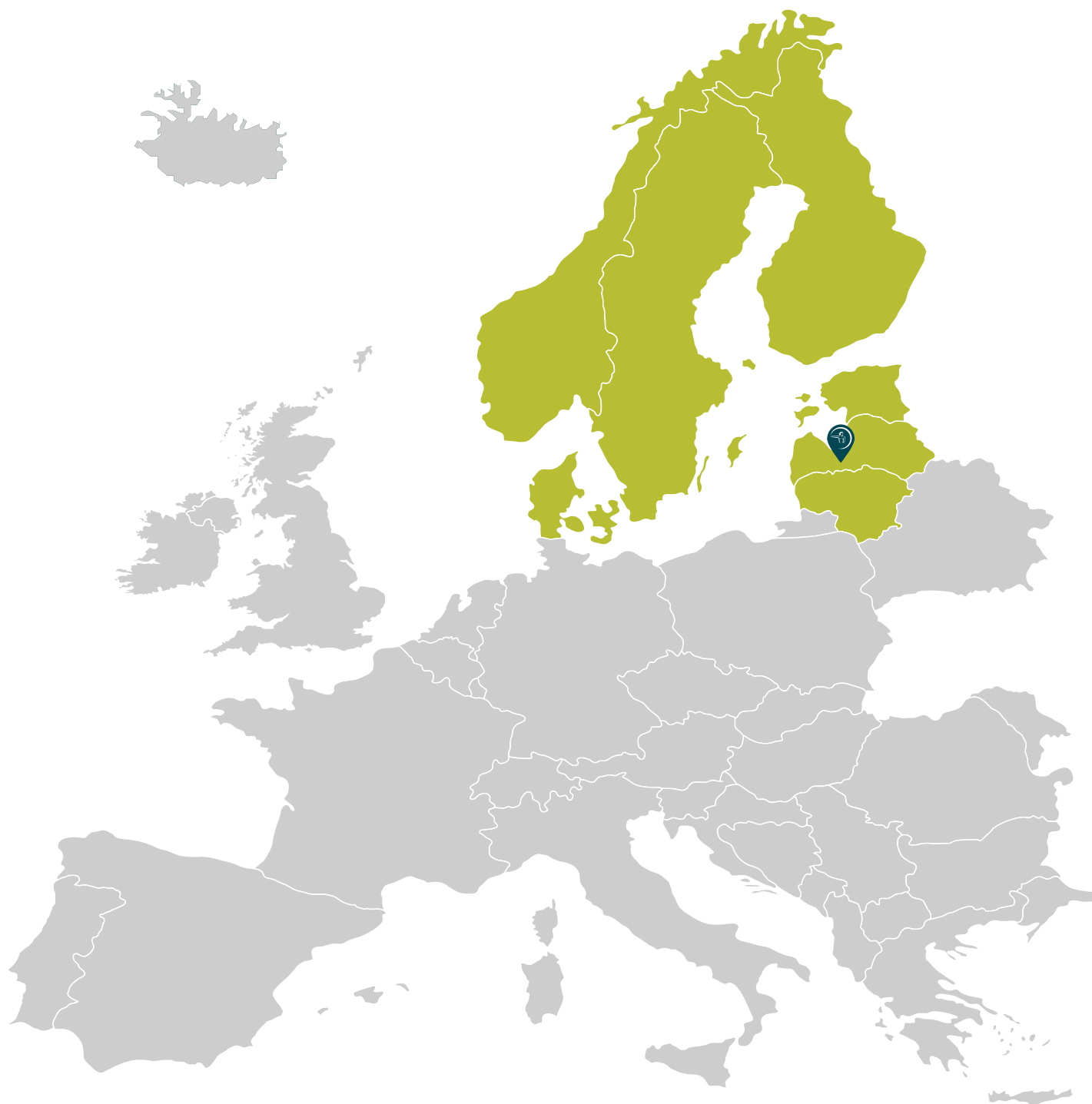

## PRODUCTION AND OFFICE

SIA "EVOPIPES"

Address: Langervaldes street 2a,  
Jelgava, LV-3002, Latvia

Telephone: +371 630-943-00

[info@evopipes.lv](mailto:info@evopipes.lv)

[www.evopipes.lv](http://www.evopipes.lv)